

OWNER'S MANUAL

LED LCD MONITOR

Please read this manual carefully before operating your set and retain it for future reference.

LED LCD MONITOR MODEL

22M47D	23M47D	24M47D
22M47VQ	23M47VQ	24M47VQ
22M47H	23M47H	24M47H
22M47HQ		24M47HQ

CONTENTS

3 LICENSE

4 ASSEMBLING AND PREPARING

- 4 Unpacking
- 6 Parts and buttons
- 7 - How to Use the Joystick Button
- 8 Moving and Lifting the Monitor
- 9 Setting up the Monitor set
- 9 - Attaching the Stand Base
- 9 - Detaching the Stand Base
- 10 - Mounting on a table
- 10 - Using the cable holder
- 12 - Mounting on a wall

13 USING THE MONITOR SET

- 13 Connecting to a PC
- 13 - D-SUB connection
- 13 - DVI-D connection
- 13 - HDMI connection
- 14 Connecting to AV Devices
- 14 - HDMI connection
- 15 Connecting to External Devices
- 15 - Peripheral device connection

16 INSTALLING THE LG MONITOR SOFTWARE

- 16 Installing The Screen Split

18 CUSTOMIZING SETTINGS

- 19 Customizing settings
- 19 - Menu Settings
- 19 - -Quick Settings
- 21 - -Picture
- 23 - -General
- 24 - -Auto Configuration
- 25 - -Reset
- 26 - -Picture mode

27 TROUBLESHOOTING

29 SPECIFICATIONS

- 35 Preset Modes (Resolution)
- 35 Indicator

36 PROPER POSTURE

- 36 Proper posture for using the Monitor set.

22M47VQ 22M47H 22M47HQ 23M47VQ 23M47H 24M47H 24M47HQ 24M47VQ

LICENSE

Each model has different licenses. Visit www.lg.com for more information on the license.



The terms HDMI and HDMI High-Definition Multimedia Interface, and the HDMI logo are trademarks or registered trademarks of HDMI Licensing LLC in the United States and other countries.

The following content is only applied to the monitor which is sold in Europe market and which needs to meet the ErP Directive:

* This monitor is set to be turned off automatically in 4 hours after you turned on display if there is no adjustment to display.

* To make this setting be disabled, change the option to 'Off' in OSD menu of "Automatic Standby".

ASSEMBLING AND PREPARING

Unpacking

Check your product box for the following items. If there are any missing accessories, contact the local dealer where you purchased your product. The illustrations in this manual may differ from the actual product and accessories.



CD(Owner's Manual) / Card

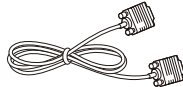

D-SUB Cable
(This cable is not included in all countries.)

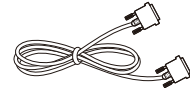

DVI-D Cable

22M47D	22M47VQ	23M47D
23M47VQ	24M47D	24M47VQ

 (This cable is not included in all countries.)



Power Cord
(Depending on the country)

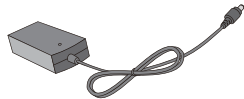

AC-DC Adapter

or

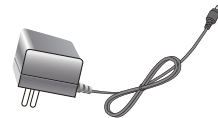

AC-DC Adapter
(Depending on the country)

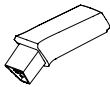

Stand Body

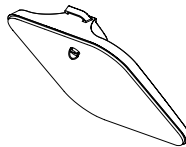

Stand Base



HDMI Cable

22M47VQ	23M47VQ	24M47VQ
22M47H	23M47H	24M47H
22M47HQ		24M47HQ

 (This cable is not included in all countries.)

**CAUTION**

- Do not use any unapproved accessories to ensure the safety and product life span.
- Any damages or injuries by using unapproved accessories are not covered by the warranty.

**NOTE**

- The accessories supplied with your product may vary depending on the model.
- Product specifications or contents in this manual may be changed without prior notice due to upgrade of product functions.

Parts and buttons

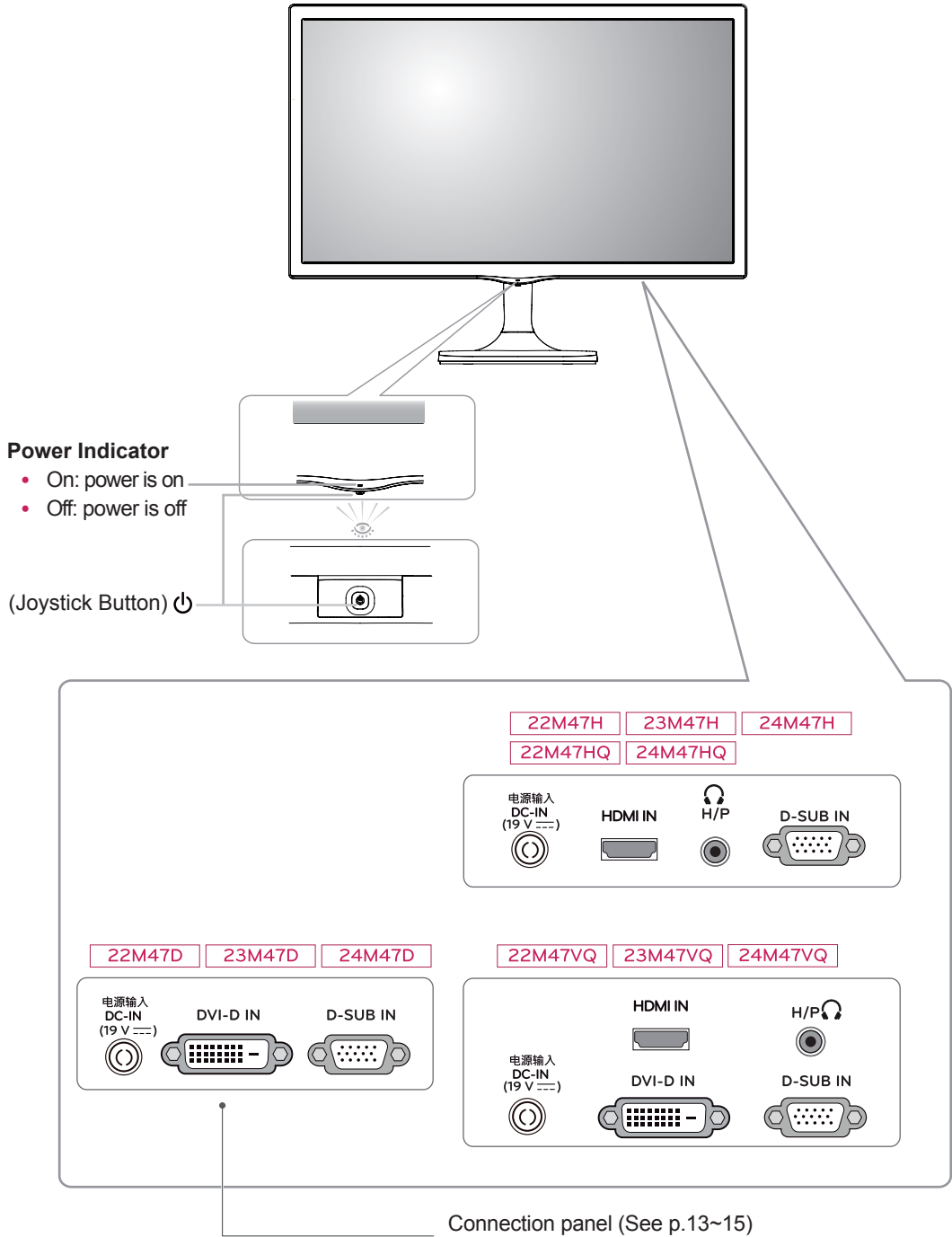





NOTE

- The joystick button is located at the bottom of the monitor.

How to Use the Joystick Button

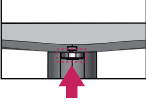
You can easily control the functions of the monitor by pressing the joystick button or moving it left/right with your finger.

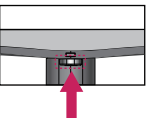
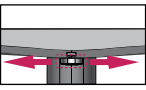
Basic Functions

		Power on	Press the joystick button once with your finger to turn on the monitor.
		Power off	Press and hold the joystick button once with your finger to turn off the monitor.
		Volume Control	You can control the volume by moving the joystick button left/right.

Moving and Lifting the Monitor

When moving or lifting the monitor, follow these instructions to prevent the monitor from being scratched or damaged and to ensure safe transportation regardless of its shape or size.

- It is advisable to place the monitor in the original box or packing material before attempting to move it.
- Before moving or lifting the monitor, disconnect the power cord and all cables.
- Hold the top and bottom of the monitor frame firmly. Do not hold the panel itself.

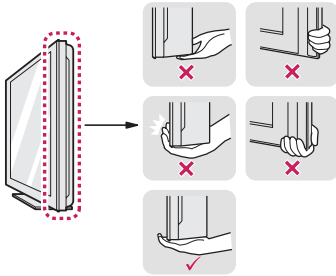

- When holding the monitor, the screen should face away from you to prevent it being scratched.



- When moving the monitor, avoid any strong shock or vibrations to the product.
- When moving the monitor, keep it upright, never turn the monitor on its side or tilt it sideways.



CAUTION

- As far as possible, avoid touching the monitor screen. This may result in damage to the screen or some of the pixels used to create images.

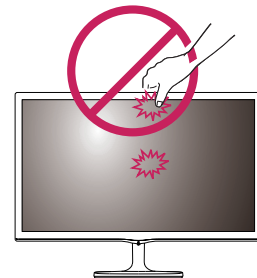

Setting up the Monitor set

Attaching the Stand Base

- 1 Place the Monitor set with the screen side down on a flat and cushioned surface.



CAUTION

Lay a foam mat or soft protective cloth on the surface to protect the screen from damage.

- 2
 - 1 Attach the **Stand Body** to the monitor set.
 - 2 Attach the **Stand Base** to **Stand Body**.
 - 3 Tighten the screw to the right.

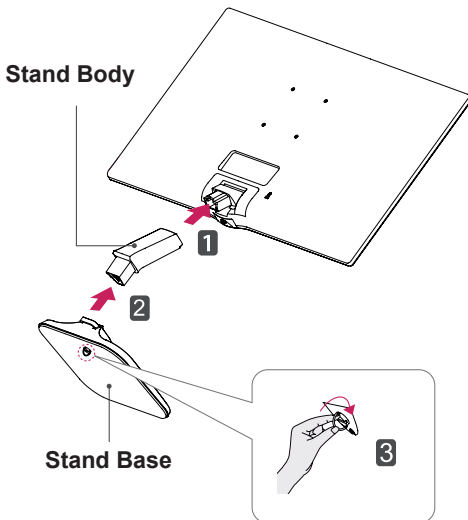

Detaching the Stand Base

- 1 Place the Monitor set with the screen side down on a flat and cushioned surface.
- 2
 - 1 Pull out the **Stand Body** and **Stand Base** from the monitor set.
 - 2 Turn the screw to the left.
 - 3 Pull out the **Stand Base**.

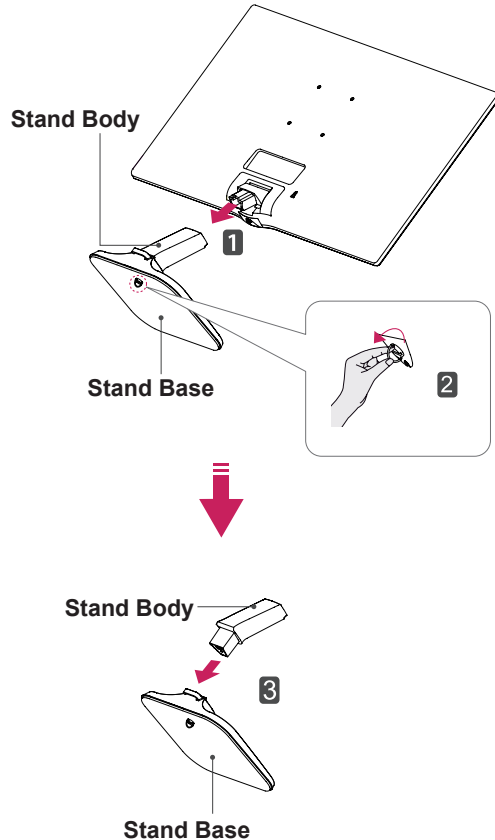

CAUTION

- Illustrations in this document represent typical procedures, so they may look different from the actual product.
- Do not carry the monitor upside down by just holding the stand base. This may cause the monitor to fall off the stand and could result in personal injury.
- When lifting or moving the monitor, do not touch the monitor screen. The force applied to the monitor screen may cause damage to it.
- If you use the monitor panel without the stand base, its joystick button may cause the monitor to become unstable and fall, resulting in damage to the monitor or human injury. In addition, this may cause the joystick button to malfunction.

Mounting on a table

- 1 Lift and tilt the Monitor set into its upright position on a table.
Leave a 10 cm (minimum) space from the wall for proper ventilation.

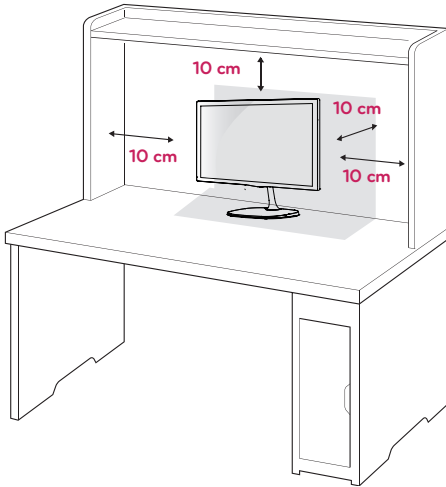

- 2 Connect the AC-DC Adapter and Power Cord to a wall outlet.

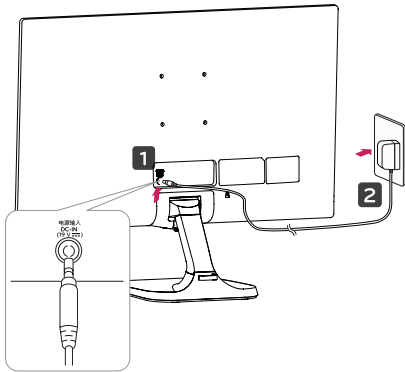

or

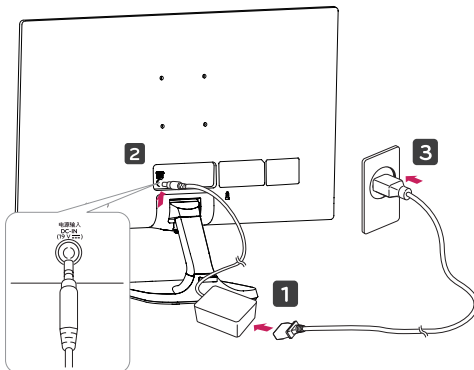

- 3 Press the joystick button on the bottom of the monitor to turn on the monitor.



CAUTION

Unplug the power cord before moving the Monitor to another location. Otherwise electric shock may occur.

Using the cable holder

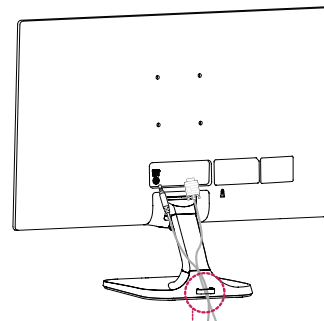

Cable holder

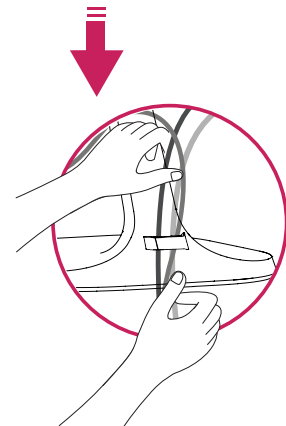

WARNING

When you adjust the angle, do not hold the bottom of the Monitor set frame as shown on the following illustration, as may injure your fingers.

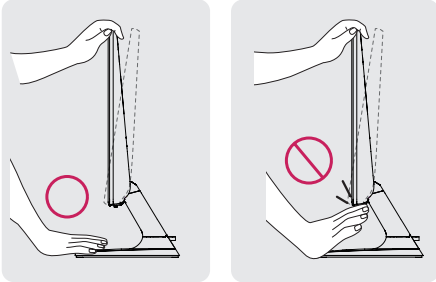

When adjusting the angle, may cause damage or abnormality over excessive force.

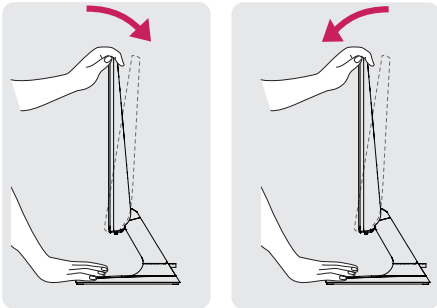

Do not touch or press the screen when adjusting the angle of the monitor.

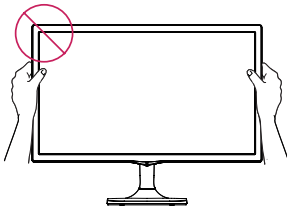

Do not hold this set like below picture. Monitor screen can detach from stand base and injure your body.

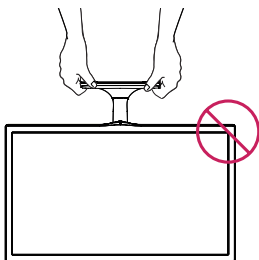

NOTE

Tilt from +20 to -5 degrees up or down to adjust the angle of the Monitor set to suit your view.

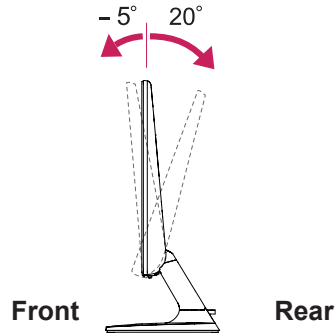

Using the Kensington security system

The Kensington security system connector is located at the back of the Monitor set. For more information of installation and using, refer to the manual supplied with the Kensington security system or visit <http://www.kensington.com>.

Connect the Kensington security system cable between the Monitor set and a table.

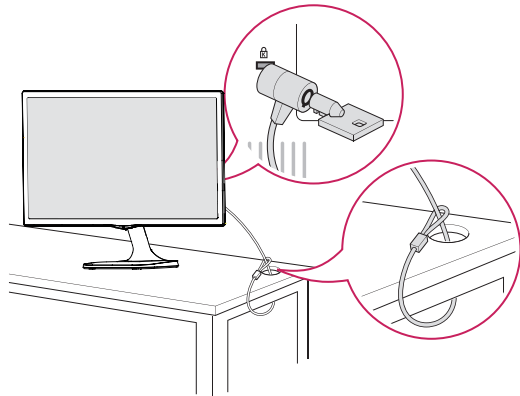

NOTE

The Kensington security system is optional. You can obtain it from most electronics stores.

Mounting on a wall

For proper ventilation, allow a clearance of 10 cm on each side and from the wall. Detailed instructions are available from your dealer, see the optional Tilt Wall Mounting Bracket Installation and Setup Guide.

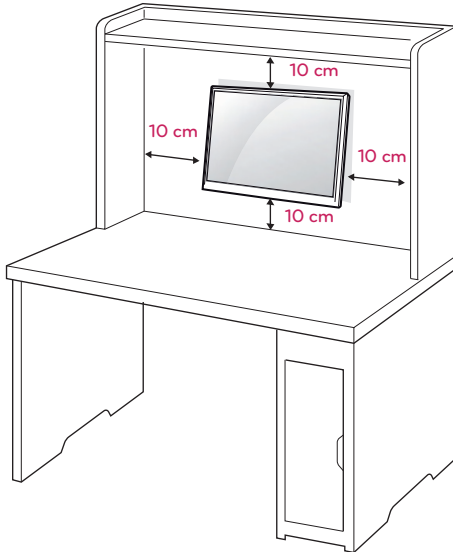

If you intend to mount the Monitor set to a wall, attach Wall mounting interface (optional parts) to the back of the set.

When you install the Monitor set using a wall mounting interface (optional parts), attach it carefully so it will not drop.

- 1 If you use screw longer than standard, the monitor might be damaged internally.
- 2 If you use improper screw, the product might be damaged and drop from mounted position. In this case, LG Electronics is not responsible for it.

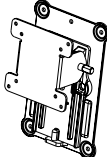
Model	22M47D	23M47D	24M47D
	22M47VQ	23M47VQ	24M47VQ
	22M47H	23M47H	24M47H
	22M47HQ		24M47HQ
Wall Mount (A x B)	75 x 75		
Standard screw	M4 x L10		
Number of screws	4		
Wall Mount Plate (Optional)	RW120 		

- VESA (A x B)

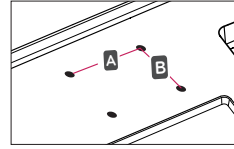

! CAUTION

- Disconnect the power cord first, and then move or install the Monitor set. Otherwise electric shock may occur.
- If you install the Monitor set on a ceiling or slanted wall, it may fall and result in severe injury.
- Use only an authorized LG wall mount and contact the local dealer or qualified personnel.
- Do not over tighten the screws as this may cause damage to the Monitor set and void your warranty.
- Use only screws and wall mounts that meet the VESA standard. Any damages or injuries by misuse or using an improper accessory are not covered by the warranty.
- Screw length from outer surface of back cover should be under 8mm.

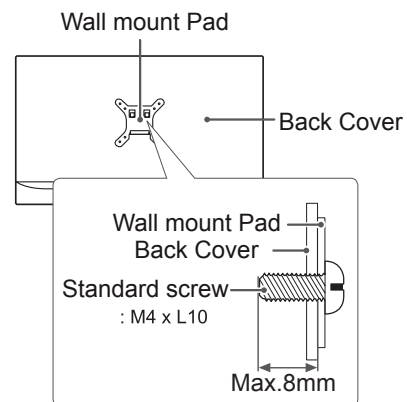

! NOTE

- Use the screws that are listed on the VESA standard screw specifications.
- The wall mount kit will include an installation manual and necessary parts.
- The wall mount bracket is optional. You can obtain additional accessories from your local dealer.
- The length of screws may differ depending on the wall mount. Be sure to use the proper length.
- For more information, refer to the instructions supplied with the wall mount.

USING THE MONITOR SET

Connecting to a PC

- Your Monitor set supports Plug & Play*.
*Plug & Play: A PC recognizes a connected device that users connect to a PC and turn on, without device configuration or user intervention.

D-SUB connection

Transmits analog video from your PC to the Monitor set. Connect the PC and the Monitor set with the supplied D-sub 15 pin signal cable as shown in the following illustrations.

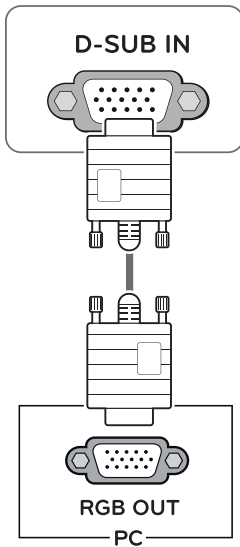

NOTE

- When using a D-Sub signal input cable connector for Macintosh

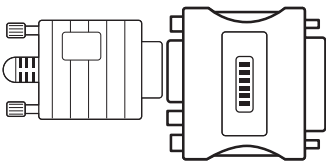

- Mac adapter**
For Apple Macintosh use, a separate plug adapter is needed to change the 15 pin high density (3 row) D-SUB VGA connector on the supplied cable to a 15 pin 2 row connector.

DVI-D connection

Transmits a digital video signal from your PC to the Monitor set. Connect the PC and the Monitor set with a DVI cable as shown in the following illustrations.

22M47D	23M47D	24M47D
22M47VQ	23M47VQ	24M47VQ

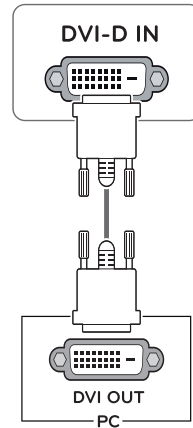

HDMI connection

Transmits the digital video and audio signals from your PC to the Monitor set. Connect the PC and the Monitor set with the HDMI cable as shown in the following illustrations.

22M47VQ	23M47VQ	24M47VQ
22M47H	23M47H	24M47H
22M47HQ		24M47HQ

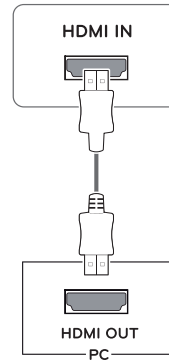

NOTE

- If you use HDMI PC, it can cause compatibility problem.

**CAUTION**

- Connect the signal input cable and tighten it by turning the screws clockwise.
- Do not press the screen with your finger for a long time as this may result in temporary distortion on the screen.
- Avoid displaying a fixed image on the screen for a long period of time to prevent image burn. Use a screensaver if possible.

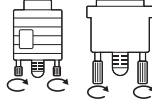
**NOTE**

- When you want to use two PC in our Monitor, please connect the signal cable(D-SUB/ DVI-D/HDMI) respectively in Monitor set.
- If you turn the Monitor set on while it is cold, the screen may flicker. This is normal.
- Some red, green, or blue spots may appear on the screen. This is normal.

Connecting to AV Devices

HDMI connection

Transmits the digital video and audio signals from your AV devices to the monitor. Connect your AV device to the monitor with the HDMI cable as illustrated below.

22M47VQ	23M47VQ	24M47VQ
22M47H	23M47H	24M47H
22M47HQ		24M47HQ

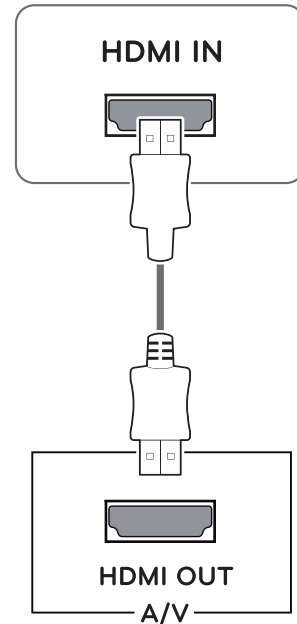
**NOTE**

- If you use HDMI PC, it can cause compatibility problem.

Connecting to External Devices

Peripheral device connection

Connect peripheral devices to the monitor using headphone ports.

22M47VQ	23M47VQ	24M47VQ
22M47H	23M47H	24M47H
22M47HQ	24M47HQ	

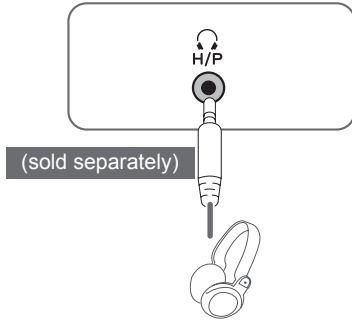

NOTE

- Peripheral devices are sold separately.
- Cables with angled plugs may have clearance issues, use straight plugs when possible.



Angle Type

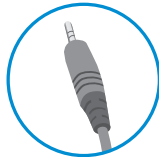

Straight Type

NOTE

- Headphones or speakers may not work normally, depending on the server PC settings.

INSTALLING THE LG MONITOR SOFTWARE

Installing The Screen Split

Insert the the owner's manual CD included in the product package into your PC's CD driver and install the LG Monitor Software.

- 1 Set the default Web browser to Internet Explorer.

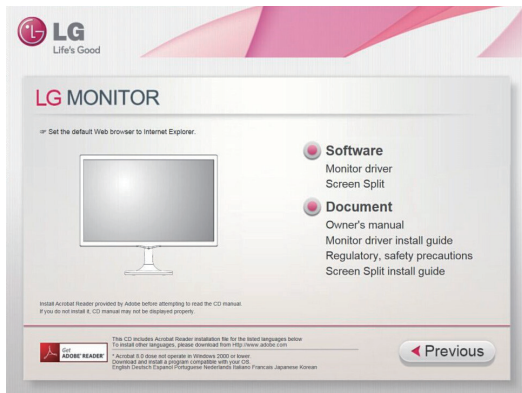

- 2 Click the "Screen Split" on the CD's main screen. When the file download window appears, click the Run button. (The file download window may vary depending on the operating system and the Internet Explorer version, but the installation procedures are same.)

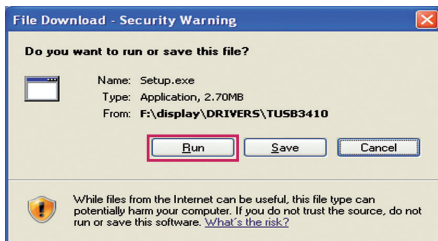

- 3 Follow the instructions to proceed with the installation.

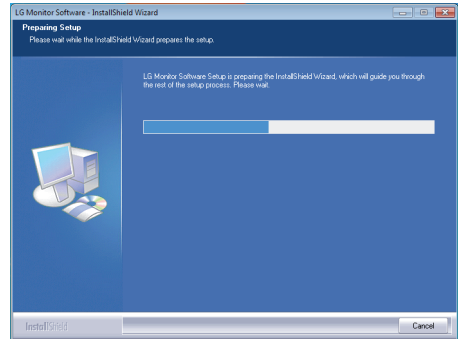

- 4 Check "I accept the terms of the agreement" on the License Agreement screen and then click the [Next] button.

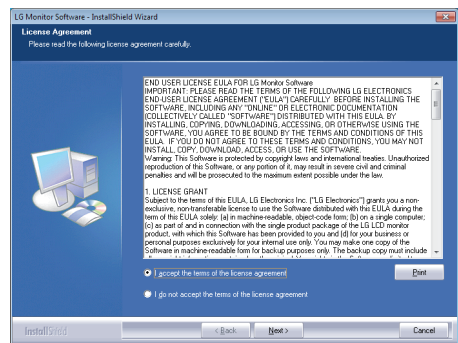

CAUTION

- Service Pack 1 or higher is required for Windows 7 & Windows 8.

5 The Screen Split installation starts as shown below.

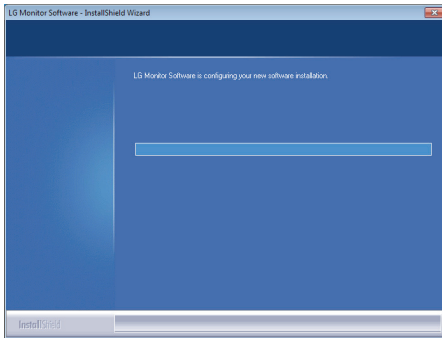

6 When the installation is complete, restart your system.

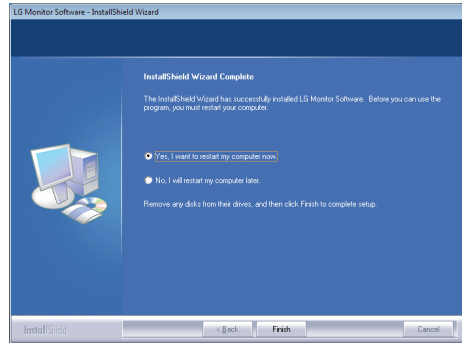

NOTE

- Screen Split: This program automatically splits the program window as desired.
- ※ Monitor Selection only supported in extend display.
- ※ This program supported Windows 7& Windows 8.

NOTE

If you run Screen Split, the Screen Split icon [] appears in the system tray at the right bottom of the PC screen.



Right-click the Screen Split icon and select a layout you want.

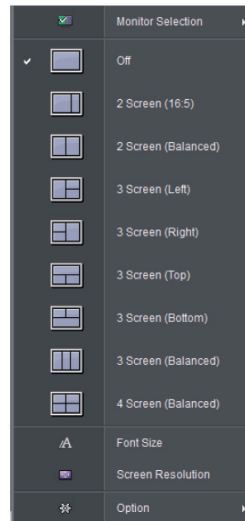

CUSTOMIZING SETTINGS

Activating the Main Menu

- 1 Press the joystick button on the bottom of the monitor.
- 2 Move the joystick up/down (▲/▼) and left/right(◀/▶) to set the options.
- 3 Press the joystick button once more to exit the main menu.

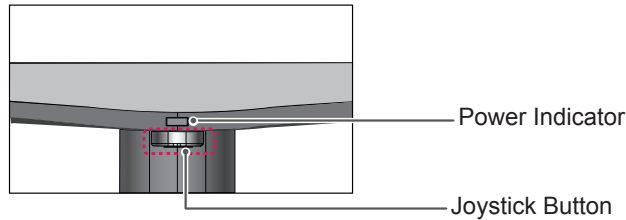

Button	Menu Status	Description												
	Main menu disabled	Enables the main menu.												
	Main menu enabled	Exits the main menu. (Holding down the button to turn off the monitor: You can turn off the monitor this way at any time, including when the OSD is on.)												
	Main menu disabled	<table border="1"> <tr> <td>22M47VQ</td> <td>23M47VQ</td> <td>24M47VQ</td> </tr> <tr> <td>22M47H</td> <td>23M47H</td> <td>24M47H</td> </tr> <tr> <td>22M47HQ</td> <td></td> <td>24M47HQ</td> </tr> </table> Adjusts the monitor volume level. <table border="1"> <tr> <td>22M47D</td> <td>23M47D</td> <td>24M47D</td> </tr> </table> Enables the navigation OSD.	22M47VQ	23M47VQ	24M47VQ	22M47H	23M47H	24M47H	22M47HQ		24M47HQ	22M47D	23M47D	24M47D
		22M47VQ	23M47VQ	24M47VQ										
	22M47H	23M47H	24M47H											
	22M47HQ		24M47HQ											
22M47D	23M47D	24M47D												
Main menu enabled	Enters the menu features.													
Main menu disabled	<table border="1"> <tr> <td>22M47VQ</td> <td>23M47VQ</td> <td>24M47VQ</td> </tr> <tr> <td>22M47H</td> <td>23M47H</td> <td>24M47H</td> </tr> <tr> <td>22M47HQ</td> <td></td> <td>24M47HQ</td> </tr> </table> Adjusts the monitor volume level. <table border="1"> <tr> <td>22M47D</td> <td>23M47D</td> <td>24M47D</td> </tr> </table> Enables the navigation OSD.	22M47VQ	23M47VQ	24M47VQ	22M47H	23M47H	24M47H	22M47HQ		24M47HQ	22M47D	23M47D	24M47D	
	22M47VQ	23M47VQ	24M47VQ											
22M47H	23M47H	24M47H												
22M47HQ		24M47HQ												
22M47D	23M47D	24M47D												
Main menu enabled	Operates the Input change.													
	Main menu disabled	Enables the main menu.												
	Main menu enabled	Enters the reader feature.												
	Main menu disabled	Enables the main menu.												
	Main menu enabled	Turns off the monitor.												

Main Menu Features

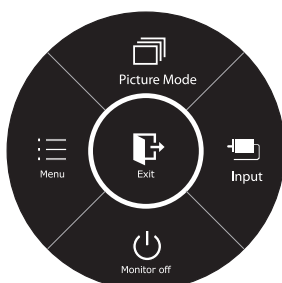

Main Menu	Description
Menu	Configures the screen settings.
Picture Mode	Select picture mode to achieve the best display effect.
Input	You can choose the input signal. <ul style="list-style-type: none"> • When two input signals are connected, you can select the input signal (D-SUB/DVI-D/HDMI) you want. • When only one signal is connected, it is automatically detected. The default setting is D-SUB.
Monitor off	Turns off the monitor.
Exit	Exits the main menu.

Customizing settings

Menu Settings

-Quick Settings

- 1 To view the **OSD menu**, press the **joystick button** at the bottom of the monitor and then enter the **Menu**.
- 2 Go to **Quick Settings > Brightness** by moving the joystick.
- 3 Configure the options following the instructions that appear in the bottom right corner.
- 4 To return to the upper menu or set other menu items, move the joystick to ◀ or pressing (⊙ / OK) it.
- 5 If you want to exit the OSD menu, move the joystick to ◀ until you exit.

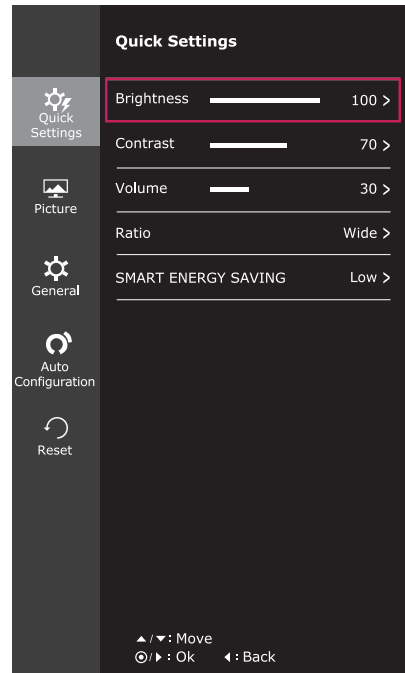

Each option is described below.

Menu > Quick Settings	Description								
Brightness	Adjusts the color contrast and brightness of the screen.								
Contrast									
Volume	Adjusts the volume.								
<table border="1" style="font-size: small;"> <tr> <td>22M47VQ</td> <td>23M47VQ</td> <td>24M47VQ</td> </tr> <tr> <td>22M47H</td> <td>23M47H</td> <td>24M47H</td> </tr> <tr> <td>22M47HQ</td> <td></td> <td>24M47HQ</td> </tr> </table>			22M47VQ	23M47VQ	24M47VQ	22M47H	23M47H	24M47H	22M47HQ
22M47VQ	23M47VQ	24M47VQ							
22M47H	23M47H	24M47H							
22M47HQ		24M47HQ							
Ratio	<div style="border: 1px solid gray; padding: 5px;"> <p>NOTE</p> <ul style="list-style-type: none"> Jog joystick button down () in the Volume menu will enable/disable the Mute function. </div>								
	Wide	Displays the video in wide-screen, regardless of the video signal input.							
	Original	Displays a video according to the input video signal aspect ratio.							
SMART ENERGY SAVING	High	Enables SMART ENERGY SAVING you can save energy with this energy- high efficient function.							
	Low	Enables SMART ENERGY SAVING you can save energy with this energy- low efficient function.							
	Off	Disables SMART ENERGY SAVING .							

NOTE

- The display may look the same for Wide, Original options at the recommended resolution (1920 x 1080).
- The ratio is disabled in the interlaced signal.

**NOTE**

- **TOTAL POWER REDUCTION:** How much power is saved while using the monitor.
- **TOTAL CO2 REDUCTION:** Change the TOTAL POWER REDUCTION to CO2.
- **SAVING DATA(W/h)**

	546 mm (21.5 inch)	584 mm (23 inch)	600 mm (23.6 inch)
SMART SAVING (High)	4 W/h	4 W/h	4 W/h
SMART SAVING (Low)	2 W/h	2 W/h	2 W/h

- Saving Data depends on the Panel. So, those values should be different from each panel and panel vendor. If option of SMART ENERGY SAVING is High or Low, monitor luminance becomes higher or lower depending on source.
- LG calculated these values by using **“broadcast video signal”** (including broadcast video: IEC 62087)
- SMART SAVING refers to how much power can be saved using the SMART ENERGY SAVING function.
- If option of SMART ENERGY SAVING is High or Low, Picture Mode will automatically be Custom and Reader Mode and Color Wizard will automatically be Off.

-Picture

- 1 To view the **OSD menu**, press the **joystick button** at the bottom of the monitor and then enter the **Menu**.
- 2 Go to **Picture** by moving the joystick.
- 3 Configure the options following the instructions that appear in the bottom right corner.
- 4 To return to the upper menu or set other menu items, move the joystick to ◀ or pressing (⊙ / OK) it.
- 5 If you want to exit the OSD menu, move the joystick to ◀ until you exit.

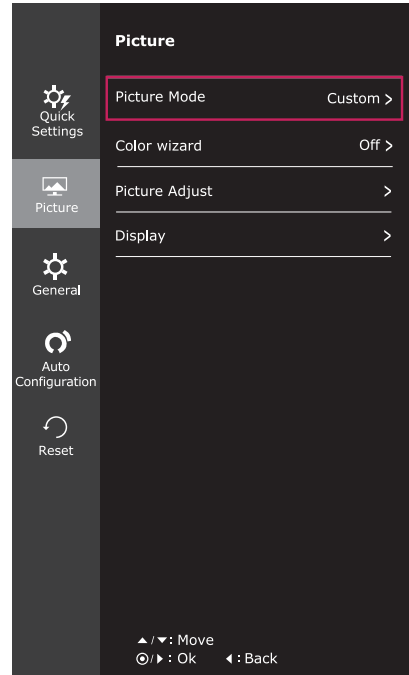

Each option is described below.

Menu > Picture	Description	
Picture Mode	Custom	Allows the user to adjust each element. The color mode of the main menu can be adjusted.
	Reader 1	It is a mode that the screen is adjusted to the best for the newspaper. If you want screen more bright, you can control brightness in Menu OSD.
	Reader 2	It is a mode that the screen is adjusted to the best for the cartoon. If you want screen more bright, you can control brightness in Menu OSD.
	Photo	Optimizes the screen to view photos.
	Cinema	Optimizes the screen to improve the visual effects of a video.
	Game	Optimizes the screen for gameplay.
Color wizard	Red weakness	It is a mode for user who has inability to see red color. It make color weakness user can easily distinguish red colors.
	Green weakness	It is a mode for user who has inability to see green color. It make color weakness user can easily distinguish green colors.
	Off	It is a mode that Color Wizard mode is off.

Picture Adjust	Picture	SUPER RESOLUTION+	High	Optimized picture quality is displayed when a user wants crystal clear images. It is effective for high quality video or game.											
			Middle	The optimized picture quality is displayed when a user wants images between low and high modes for comfortable viewing. It is effective for UCC or SD video.											
			Low	The optimized picture quality is displayed when a user wants smooth and natural images. It is effective for slow-moving pictures or still images.											
			Off	Select this option for everyday viewing. SUPER RESOLUTION+ is turned off in this mode.											
		Sharpness		Adjusts the sharpness of the screen.											
		Black Level		Sets the offset level (for HDMI only).											
		<table border="1"> <tr> <td>22M47VQ</td> <td>23M47VQ</td> <td>24M47VQ</td> </tr> <tr> <td>22M47H</td> <td>23M47H</td> <td>24M47H</td> </tr> <tr> <td>22M47HQ</td> <td></td> <td>24M47HQ</td> </tr> </table>		22M47VQ	23M47VQ	24M47VQ	22M47H	23M47H	24M47H	22M47HQ		24M47HQ	<ul style="list-style-type: none"> Offset: as a reference for a video signal, this is the darkest color the monitor can display. 		
		22M47VQ	23M47VQ	24M47VQ											
		22M47H	23M47H	24M47H											
		22M47HQ		24M47HQ											
				High	The picture of the screen gets brighter.										
				Low	The picture of the screen gets darker.										
		Response Time		Sets a response time for displayed pictures based on the speed of the screen. For a normal environment, it is recommended that you use Normal. For a fast-moving picture, it is recommended that you use High. Setting to High may cause image sticking.											
		<table border="1"> <tr> <td>22M47VQ</td> <td>23M47VQ</td> <td>24M47VQ</td> </tr> <tr> <td>22M47H</td> <td></td> <td>24M47H</td> </tr> </table>		22M47VQ	23M47VQ	24M47VQ	22M47H		24M47H	High	Sets the response time to High.				
	22M47VQ	23M47VQ	24M47VQ												
	22M47H		24M47H												
			Middle	Sets the response time to Middle.											
			Low	Sets the response time to Low.											
			Off	Sets the response time to Off.											
	Over Scan		To select the range of output image for DTV timing in HDMI input. (only for HDMI input) Recommend overscan function to turn on when connect AV equipment.												
	<table border="1"> <tr> <td>22M47VQ</td> <td>23M47VQ</td> <td>24M47VQ</td> </tr> <tr> <td>22M47H</td> <td>23M47H</td> <td>24M47H</td> </tr> <tr> <td>22M47HQ</td> <td></td> <td>24M47HQ</td> </tr> </table>		22M47VQ	23M47VQ	24M47VQ	22M47H	23M47H	24M47H	22M47HQ		24M47HQ				
22M47VQ	23M47VQ	24M47VQ													
22M47H	23M47H	24M47H													
22M47HQ		24M47HQ													
Color	Gamma	Set your own gamma value. : Gamma 0, Gamma 1, Gamma 2, Off on the monitor, high gamma values display whitish images and low gamma values display blackish images. If user don't want adjusted gamma, user can select Gamma off.													
	Color Temp	Selects the factory default picture color. Warm: Sets the screen color to a reddish tone. Medium: Sets the screen color between a red and blue tone. Cool: Sets the screen color to a bluish tone.													
		Custom													
		Red Green Blue	You can customize the picture color using Red, Green, and Blue colors.												
	Six Color	Meets the user requirements for colors through adjusting the color and saturation of the six colors (Red_Hue, Red_Saturation, Green_Hue, Green_Saturation, Blue_Hue, Blue_Saturation, Cyan_Hue, Cyan_Saturation, Magenta_Hue, Magenta_Saturation, Yellow_Hue, Yellow_Saturation) and saving the settings.													
*Hue: Adjusts tone of the screen. *Saturation: Adjusts the saturation of the screen colors. The lower the value, less saturated and bright the colors become. The higher the value, the more saturated and dark the colors become.															
	Reset	Returns the color settings to the default settings.													
Display	Horizontal	To move image left and right.													
	Vertical	To move image up and down.													
	Clock	To minimize any vertical bars or stripes visible on the screen background. The horizontal screen size will also change.													
	Phase	To adjust the focus of the display. This item allows you to remove any horizontal noise and clear or sharpen the image of characters.													

-General

- 1 To view the **OSD menu**, press the **joystick button** at the bottom of the monitor and then enter the **Menu**.
- 2 Go to **General** by moving the joystick.
- 3 Configure the options following the instructions that appear in the bottom right corner.
- 4 To return to the upper menu or set other menu items, move the joystick to ◀ or pressing (⊙ / OK) it.
- 5 If you want to exit the OSD menu, move the joystick to ◀ until you exit.

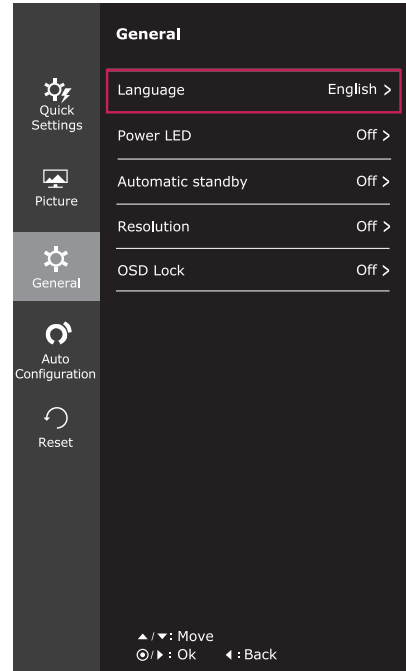

Each option is described below.

Menu > General	Description									
Language	To choose the language in which the control names are displayed.									
Power LED	Turns the power indicator on the front side of the monitor on/off.									
	On The power indicator is automatically turned on.									
	Off The power indicator is automatically turned on.									
Automatic Standby <table border="1" style="font-size: small;"> <tr> <td>22M47VQ</td> <td>23M47VQ</td> <td>24M47VQ</td> </tr> <tr> <td>22M47H</td> <td>23M47H</td> <td>24M47H</td> </tr> <tr> <td>22M47HQ</td> <td></td> <td>24M47HQ</td> </tr> </table>	22M47VQ	23M47VQ	24M47VQ	22M47H	23M47H	24M47H	22M47HQ		24M47HQ	The monitor will automatically switch to standby mode after a certain period.
22M47VQ	23M47VQ	24M47VQ								
22M47H	23M47H	24M47H								
22M47HQ		24M47HQ								
Resolution	User can set the desired resolution. This option is enabled only when the screen resolution on your computer is set to the following.									
	NOTE — The function is enabled only when the screen resolution on your computer is set to the following, except that the PC output wrong resolution.									
	1024x768, 1280x768, 1360x768, 1366x768, Off									
	1280x960, 1600x900, Off									
	1440x900, 1600x900, Off									
OSD Lock	Prevents incorrect key input.									
	On Key input is disabled.									
	NOTE — All functions except for the OSD Lock mode and the Exit button for Brightness, Contrast, Volume, Input, and General are disabled.									
Off Key input is enabled.										

-Auto Configuration

- 1 To view the **OSD menu**, press the **joystick button** at the bottom of the monitor and then enter the **Menu**.
- 2 Go to **Auto Configuration** by moving the joystick.
- 3 Configure the options following the instructions that appear in the bottom right corner.
- 4 To return to the upper menu or set other menu items, move the joystick to ◀ or pressing (⊙ / OK) it.
- 5 If you want to exit the OSD menu, move the joystick to ◀ until you exit.

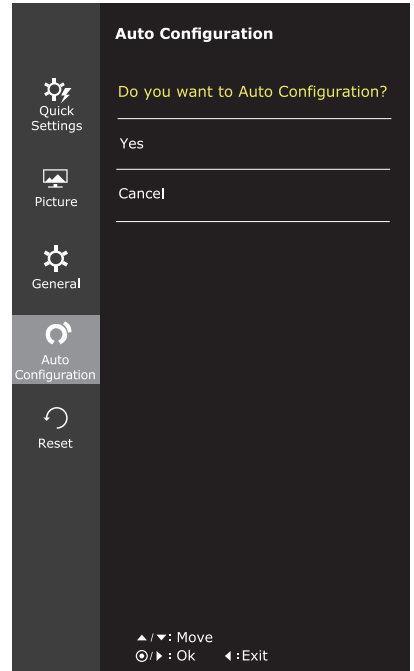

Each option is described below.

Menu > Auto Configuration	Description
Do you want to Auto configuration?	
Yes	Operate the Auto configuration for optimal display in D-SUB.
Cancel	Cancel the select.



NOTE

- This function will be enable only in analog input.

-Reset

- 1 To view the **OSD menu**, press the **joystick button** at the bottom of the monitor and then enter the **Menu**.
- 2 Go to **Reset** by moving the joystick.
- 3 Configure the options following the instructions that appear in the bottom right corner.
- 4 To return to the upper menu or set other menu items, move the joystick to ◀ or pressing (⊙ / OK) it.
- 5 If you want to exit the OSD menu, move the joystick to ◀ until you exit.

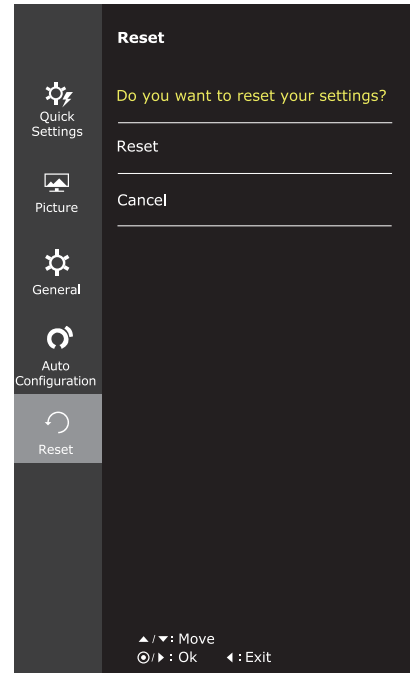

Each option is described below.

Menu > Reset	Description
Do you want to reset your settings?	
Reset	Returns to the default settings.
Cancel	Cancel the select.

-Picture mode

- 1 Press the joystick button on the bottom of the monitor.
- 2 Go to **Picture mode** by moving the joystick button to ▲.
- 3 Configure the options following the instructions that appear in the bottom.

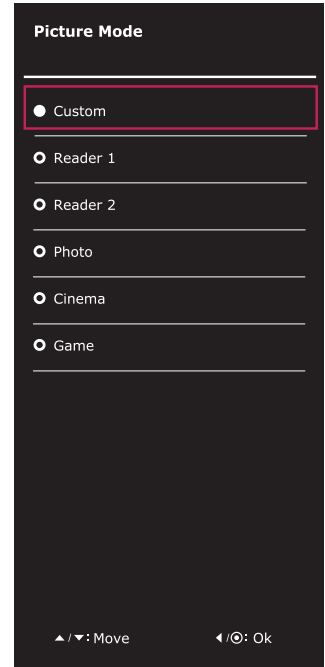

Each option is described below.

Menu > Picture Mode	Description	
Picture Mode	Custom	Allows the user to adjust each element. The color mode of the main menu can be adjusted.
	Reader 1	It is a mode that the screen is adjusted to the best for the newspaper. If you want screen more bright, you can control brightness in Menu OSD.
	Reader 2	It is a mode that the screen is adjusted to the best for the cartoon. If you want screen more bright, you can control brightness in Menu OSD.
	Photo	Optimizes the screen to view photos.
	Cinema	Optimizes the screen to improve the visual effects of a video.
	Game	Optimizes the screen for gameplay.

! NOTE

- If option of Picture Mode is non-Custom , SMART ENERGY SAVING and Color Wizard will automatically be Off.

TROUBLESHOOTING

Check the following before calling for service.

No image appears	
Is the power cord of the display connected?	<ul style="list-style-type: none"> • Check and see if the power cord is connected properly to the power outlet.
Is the power indicator light on?	<ul style="list-style-type: none"> • Press the Power button.
Is the power indicator flickering?	<ul style="list-style-type: none"> • If the display is in power saving mode, try moving the mouse or pressing any key on the keyboard to bring up the screen. • Try to turn on the PC.
Do you see an "OUT OF RANGE" message on the screen?	<ul style="list-style-type: none"> • This message appears when the signal from the PC (video card) is out of horizontal or vertical frequency range of the display. See the 'Specifications' section of this manual and configure your display again.
Do you see a "NO SIGNAL" message on the screen?	<ul style="list-style-type: none"> • When the monitor is on "No-Signal" in 5 minutes, the monitor goes to DPM mode.

Can't you control some functions in OSD?	
Do you see "OSD LOCKED" when you push MENU button? Can't you select some menu in OSD?	<ul style="list-style-type: none"> • You can secure the current control settings, so that they cannot be inadvertently changed. • You can unlock the OSD controls at any time by entering the OSD lock menu and changing items to off.

Display image is incorrect	
Display Position is incorrect.	<ul style="list-style-type: none"> • Enter the Auto Configuration function and select the "Yes" item to automatically adjust your display image to the ideal setting.
On the screen background, vertical bars or stripes are visible.	<ul style="list-style-type: none"> • Enter the Auto Configuration function and select the "Yes" item to automatically adjust your display image to the ideal setting.
Any horizontal noise appearing in any image or characters are not clearly portrayed.	<ul style="list-style-type: none"> • Enter the Auto Configuration function and select the "Yes" item to automatically adjust your display image to the ideal setting. • Check Control Panel ► Display ► Settings and adjust the display to the recommended resolution or adjust the display image to the ideal setting. Set the color setting higher than 24 bits (true color).



CAUTION

- Check **Control Panel ► Display ► Settings** and see if the frequency or the resolution were changed. If yes, readjust the video card to the recommend resolution.
- If the recommended resolution (optimal resolution) is not selected, letters may be blurred and the screen may be dimmed, truncated or biased. Make sure to select the recommend resolution.
- The setting method can differ by computer and O/S (Operation System), and resolution mentioned above may not be supported by the video card performance. In this case, please ask to the computer or the video card manufacturer.

Display image is incorrect	
The screen color is mono or abnormal.	<ul style="list-style-type: none"> • Check if the signal cable is properly connected and use a screwdriver to fasten if necessary. • Make sure the video card is properly inserted in the slot. • Set the color setting higher than 24 bits (true color) at Control Panel ► Settings.
The screen blinks.	<ul style="list-style-type: none"> • Check if the screen is set to interlace mode and if yes, change it to the recommend resolution.

Do you see an "Unrecognized monitor, Plug&Play (VESA DDC) monitor found" message?	
Have you installed the display driver?	<ul style="list-style-type: none"> • Be sure to install the display driver from the display driver CD (or diskette) that comes with your display. Or, you can also download the driver from our web site: http://www.lg.com. • Make sure to check if the video card supports Plug&Play function.

22M47VQ	23M47VQ	24M47VQ
22M47H	23M47H	24M47H
22M47HQ		24M47HQ

The screen is flickering.	
Did you select the recommended resolution?	<ul style="list-style-type: none"> • If the selected resolution is HDMI 1080i 60/50 Hz, the screen may be flickering. Change the resolution to the recommended resolution 1080P.

SPECIFICATIONS

22M47D	22M47VQ	22M47H	22M47HQ
Display	Screen Type	54.6 cm (21.5 inch) Flat Panel Active matrix-TFT LCD Anti-Glare coating Visible diagonal size: 54.6 cm	
	Pixel Pitch	0.248 mm x 0.248 mm (Pixel Pitch)	
Resolution	Max	1920 x 1080 @ 60 Hz	
	Recommend	VESA 1920 x 1080 @ 60 Hz	
Power Consumption	On Mode : 20 W (ENERGY STAR® standard)* Sleep Mode ≤ 0.3 W Off Mode ≤ 0.3 W		
Power Input	19 V $\overline{\text{---}}$ 1.2 A		
AC-DC Adapter	Type ADS-40SG-19-3 19025G, manufactured by SHENZHEN HONOR ELECTRONIC or Type ADS-40FSG-19 19025GPG-1, manufactured by SHENZHEN HONOR ELECTRONIC or Type ADS-40FSG-19 19025GPBR-1, manufactured by SHENZHEN HONOR ELECTRONIC or Type ADS-40FSG-19 19025GPI-1, manufactured by SHENZHEN HONOR ELECTRONIC or Type ADS-40FSG-19 19025GPCU-1, manufactured by SHENZHEN HONOR ELECTRONIC or Type ADS-40FSG-19 19025GPB-2, manufactured by SHENZHEN HONOR ELECTRONIC or Type LCAP21, manufactured by LIEN CHANG ELECTRONIC ENTERPRISE or Type LCAP26-A, manufactured by LIEN CHANG ELECTRONIC ENTERPRISE or Type LCAP26-E, manufactured by LIEN CHANG ELECTRONIC ENTERPRISE or Type LCAP26-I, manufactured by LIEN CHANG ELECTRONIC ENTERPRISE or Type LCAP26-B, manufactured by LIEN CHANG ELECTRONIC ENTERPRISE OUTPUT: 19 V $\overline{\text{---}}$ 1.3 A		
Dimensions (Width x Height x Depth)	With Stand	51.0 cm x 40.9 cm x 19.5 cm	
	Without Stand	51.0 cm x 31.4 cm x 6.8 cm	
Weight	2.6 kg		
Tilt Range	-5° to 20°		
Environmental conditions	Operating Temperature	10°C to 35 °C	
	Operating Humidity	10 % to 80 %	
	Storage Temperature	-20°C to 60 °C	
	Storage Humidity	5 % to 90 % non-Condensing	
Stand Base	Attached (), Detached (O)		
Power cord	Wall-outlet type		

Product specifications shown above may be changed without prior notice due to upgrade of product functions.

* The power consumption level can be different by operating condition and monitor setting.

* The On mode power consumption is measured with ENERGY STAR® test standard.

* ENERGY STAR® is a US registered mark of the United States Environmental Protection Agency.

			22M47D	22M47H	22M47HQ	22M47VQ
Sync Input	Horizontal Frequency	30 kHz to 83 kHz (Automatic)	•	•	•	•
		30 kHz to 61 kHz (Automatic)				
	Vertical Frequency	56 Hz to 75 Hz (D-SUB)	•	•	•	•
		56 Hz to 75 Hz (DVI-D)	•			•
		56 Hz to 61 Hz (HDMI)		•	•	•
	Input Form	Separate Sync.	•	•	•	•
		Digital	•	•	•	•
Video Input	Signal Input	15 pin D-SUB Connector	•	•	•	•
		DVI-D Connector (Digital)	•			•
		HDMI Connector		•	•	•
	Input Form	RGB Analog (0.7 Vp-p/75 ohm)	•	•	•	•
		Digital	•	•	•	•
Plug & Play	DDC 2B(Analog)		•	•	•	•
	DDC 2B(Digital)		•			•
	DDC 2B(HDMI)			•	•	•

SPECIFICATIONS

23M47D

23M47VQ

23M47H

Display	Screen Type	58.4 cm (23 inch) Flat Panel Active matrix-TFT LCD Anti-Glare coating Visible diagonal size: 58.4 cm
	Pixel Pitch	0.265 mm x 0.265 mm (Pixel Pitch)
Resolution	Max	1920 x 1080 @ 60 Hz
	Recommend	VESA 1920 x 1080 @ 60 Hz
Power Consumption	On Mode : 21 W (ENERGY STAR® standard)* Sleep Mode ≤ 0.3 W Off Mode ≤ 0.3 W	
Power Input	19 V --- 1.3 A	
AC-DC Adapter	Type ADS-40SG-19-3 19025G, manufactured by SHENZHEN HONOR ELECTRONIC or Type ADS-40FSG-19 19025GPG-1, manufactured by SHENZHEN HONOR ELECTRONIC or Type ADS-40FSG-19 19025GPBR-1, manufactured by SHENZHEN HONOR ELECTRONIC or Type ADS-40FSG-19 19025GPI-1, manufactured by SHENZHEN HONOR ELECTRONIC or Type ADS-40FSG-19 19025GPCU-1, manufactured by SHENZHEN HONOR ELECTRONIC or Type ADS-40FSG-19 19025GPB-2, manufactured by SHENZHEN HONOR ELECTRONIC or Type LCAP21, manufactured by LIEN CHANG ELECTRONIC ENTERPRISE or Type LCAP26-A, manufactured by LIEN CHANG ELECTRONIC ENTERPRISE or Type LCAP26-E, manufactured by LIEN CHANG ELECTRONIC ENTERPRISE or Type LCAP26-I, manufactured by LIEN CHANG ELECTRONIC ENTERPRISE or Type LCAP26-B, manufactured by LIEN CHANG ELECTRONIC ENTERPRISE OUTPUT: 19 V --- 1.3 A	
Dimensions (Width x Height x Depth)	With Stand	54.5 cm x 42.9 cm x 19.7 cm
	Without Stand	54.5 cm x 32.5 cm x 6.8 cm
Weight	2.8 kg	
Tilt Range	-5° to 20°	
Environmental conditions	Operating Temperature	10°C to 35 °C
	Operating Humidity	10 % to 80 %
	Storage Temperature	-20°C to 60 °C
	Storage Humidity	5 % to 90 % non-Condensing
Stand Base	Attached (), Detached (O)	
Power cord	Wall-outlet type	

Product specifications shown above may be changed without prior notice due to upgrade of product functions.

* The power consumption level can be different by operating condition and monitor setting.

* The On mode power consumption is measured with ENERGY STAR® test standard.

* ENERGY STAR® is a US registered mark of the United States Environmental Protection Agency.

			23M47D	23M47H	23M47VQ
Sync Input	Horizontal Frequency	30 kHz to 83 kHz (Automatic)	•	•	•
		30 kHz to 61 kHz (Automatic)			
	Vertical Frequency	56 Hz to 75 Hz (D-SUB)	•	•	•
		56 Hz to 75 Hz (DVI-D)	•		•
		56 Hz to 61 Hz (HDMI)		•	•
	Input Form	Separate Sync.	•	•	•
		Digital	•	•	•
Video Input	Signal Input	15 pin D-SUB Connector	•	•	•
		DVI-D Connector (Digital)	•		•
		HDMI Connector		•	•
	Input Form	RGB Analog (0.7 Vp-p/75 ohm)	•	•	•
		Digital	•	•	•
Plug & Play	DDC 2B(Analog)		•	•	•
	DDC 2B(Digital)		•		•
	DDC 2B(HDMI)			•	•

SPECIFICATIONS

24M47D

24M47VQ

24M47H

24M47HQ

Display	Screen Type	60.0 cm (23.6 inch) Flat Panel Active matrix-TFT LCD Anti-Glare coating Visible diagonal size: 60.0 cm
	Pixel Pitch	0.272 mm x 0.272 mm (Pixel Pitch)
Resolution	Max	1920 x 1080 @ 60 Hz
	Recommend	VESA 1920 x 1080 @ 60 Hz
Power Consumption	On Mode : 22 W (ENERGY STAR® standard)* Sleep Mode ≤ 0.3 W Off Mode ≤ 0.3 W	
Power Input	19 V --- 1.3 A	
AC-DC Adapter	Type ADS-40SG-19-3 19025G, manufactured by SHENZHEN HONOR ELECTRONIC or Type ADS-40FSG-19 19025GPG-1, manufactured by SHENZHEN HONOR ELECTRONIC or Type ADS-40FSG-19 19025GPBR-1, manufactured by SHENZHEN HONOR ELECTRONIC or Type ADS-40FSG-19 19025GPI-1, manufactured by SHENZHEN HONOR ELECTRONIC or Type ADS-40FSG-19 19025GPCU-1, manufactured by SHENZHEN HONOR ELECTRONIC or Type ADS-40FSG-19 19025GPB-2, manufactured by SHENZHEN HONOR ELECTRONIC or Type LCAP21, manufactured by LIEN CHANG ELECTRONIC ENTERPRISE or Type LCAP26-A, manufactured by LIEN CHANG ELECTRONIC ENTERPRISE or Type LCAP26-E, manufactured by LIEN CHANG ELECTRONIC ENTERPRISE or Type LCAP26-I, manufactured by LIEN CHANG ELECTRONIC ENTERPRISE or Type LCAP26-B, manufactured by LIEN CHANG ELECTRONIC ENTERPRISE	
	OUTPUT: 19 V --- 1.3 A	
Dimensions (Width x Height x Depth)	With Stand	55.7 cm x 43.8 cm x 19.7 cm
	Without Stand	55.7 cm x 34.2 cm x 6.8 cm
Weight	2.8 kg	
Tilt Range	-5° to 20°	
Environmental conditions	Operating Temperature	10°C to 35 °C
	Operating Humidity	10 % to 80 %
	Storage Temperature	-20°C to 60 °C
	Storage Humidity	5 % to 90 % non-Condensing
Stand Base	Attached (), Detached (O)	
Power cord	Wall-outlet type	

Product specifications shown above may be changed without prior notice due to upgrade of product functions.

* The power consumption level can be different by operating condition and monitor setting.

* The On mode power consumption is measured with ENERGY STAR® test standard.

* ENERGY STAR® is a US registered mark of the United States Environmental Protection Agency.

			24M47D	24M47H	24M47HQ	24M47VQ
Sync Input	Horizontal Frequency	30 kHz to 83 kHz (Automatic)	•	•	•	•
		30 kHz to 61 kHz (Automatic)				
	Vertical Frequency	56 Hz to 75 Hz (D-SUB)	•	•	•	•
		56 Hz to 75 Hz (DVI-D)	•			•
		56 Hz to 61 Hz (HDMI)		•	•	•
	Input Form	Separate Sync.	•	•	•	•
		Digital	•	•	•	•
Video Input	Signal Input	15 pin D-SUB Connector	•	•	•	•
		DVI-D Connector (Digital)	•			•
		HDMI Connector		•	•	•
	Input Form	RGB Analog (0.7 Vp-p/75 ohm)	•	•	•	•
		Digital	•	•	•	•
Plug & Play	DDC 2B(Analog)		•	•	•	•
	DDC 2B(Digital)		•			•
	DDC 2B(HDMI)			•	•	•

Preset Modes (Resolution)

D-SUB/DVI-D Timing

Display Modes (Resolution)	Horizontal Frequency(kHz)	Vertical Frequency(Hz)	Polarity(H/V)	
720 x 400	31.468	70	-/+	
640 x 480	31.469	60	-/-	
640 x 480	37.500	75	-/-	
800 x 600	37.879	60	+/+	
800 x 600	46.875	75	+/+	
1024 x 768	48.363	60	-/-	
1024 x 768	60.023	75	+/+	
1152 x 864	67.500	75	+/+	
1280 x 1024	63.981	60	+/+	
1280 x 1024	79.976	75	+/+	
1680 x 1050	65.290	60	-/+	
1920 x 1080	67.500	60	+/+	Recommend Mode

HDMI Timing

22M47VQ 22M47H 22M47HQ 23M47VQ 23M47H 24M47H 24M47HQ 24M47VQ

Factory support mode (Preset Mode)	Horizontal Frequency(kHz)	Vertical Frequency(Hz)	HDMI
480P	31.50	60	O
576P	31.25	50	O
720P	37.50	50	O
720P	45.00	60	O
1080P	56.25	50	O
1080P	67.50	60	O Recommend Mode

Indicator

Mode	LED Color
On Mode	White (Only 15 seconds)
Sleep Mode	Blinking White
Off Mode	Off

PROPER POSTURE

Proper posture for using the Monitor set.

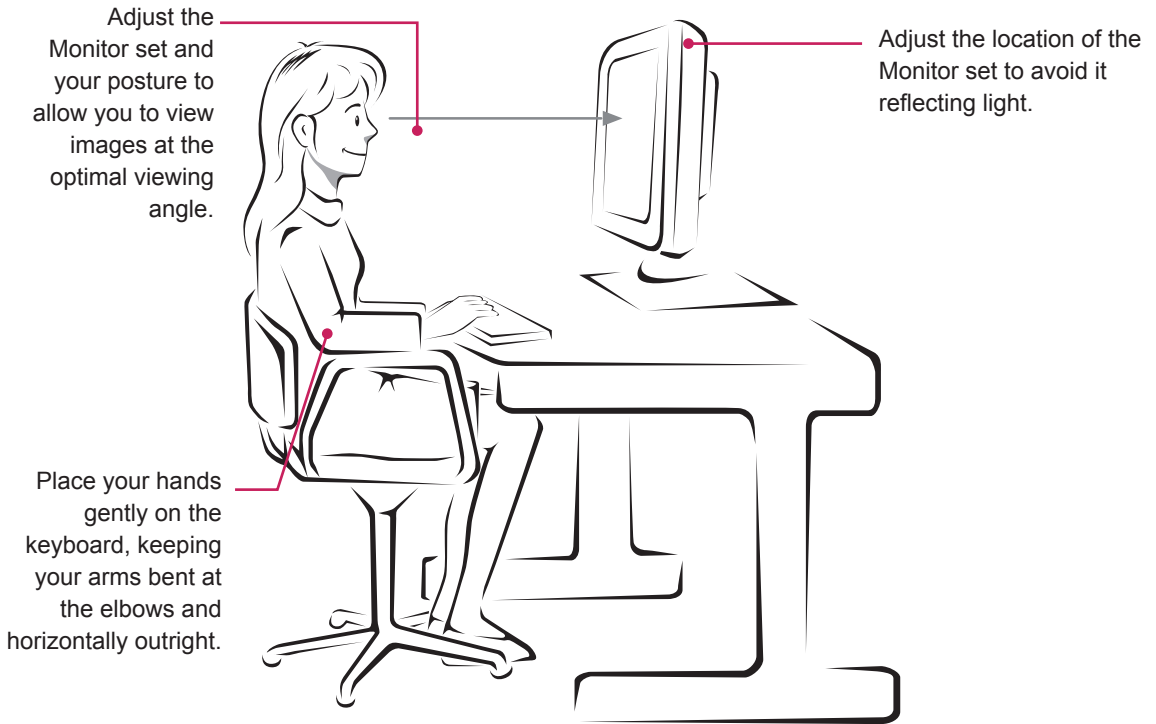



Declaration of Conformity

Trade Name: LG

Model : 22M47D,22M47VQ,22M47H,22M47HQ,
23M47D,23M47VQ,23M47H,
24M47D,24M47VQ,24M47H,24M47HQ

Responsible Party: LG Electronics Inc.

Address : 1000 Sylvan Ave. Englewood Cliffs
NJ 07632 U.S.A

TEL: 201-266-2534

*above information is only for USA FCC Regulatory

Make sure to read the Safety Precautions before using the product.

Keep the Owner's Manual (CD) in an accessible place for future reference.

The model and serial number of the SET is located on the back and one side of the SET. Record it below should you ever need service.

MODEL _____

SERIAL _____

ENERGY STAR is a set of power-saving guidelines issued by the U.S.Environmental Protection Agency(EPA).



As an ENERGY STAR Partner LGE U. S. A.,Inc. has determined that this product meets the ENERGY STAR guidelines for energy efficiency.