



HOME ALARM

A decorative graphic on the left side of the page, consisting of several thick, grey, rounded lines that form a stylized, multi-layered 'L' shape, extending from the top left towards the center of the page.

HOME ALARM SYSTEM/GSM manual

USER MANUAL

BEFORE INSTALLING AND USING THIS SYSTEM,
YOU ARE STRONGLY RECOMMENDED TO READ THIS MANUAL CAREFULLY.

MENU

1. Basic Configure-----	(01)
2. Words Explain-----	(02)
3. Attention before using-----	(03)
4. Feature & Function-----	(04)
5. Main part & instruction-----	(04)
6. Setting & Operation-----	(10)
7. Receive the Alarming phone-----	(19)
8. Remote Control Function-----	(21)
9. System Installation-----	(21)
10. Technology Parameter-----	(22)
11. Normal Fault & Solution-----	(22)
12. Accessories-----	(23)

1. Basic Configure



AL-2016A

2. Word Explain

Arm	Set to be Armed(Anti-Burglar), Armed or Make Alarm
Disarm	Exit the status of Armed or StopAlarming
Normal Vocal Arm	In Armed status, when being triggered, the siren will be warning and dial the preset phone number
Mute Arm	In Armed status, when being triggered, the siren will not be warning but dial the preset phone number
Stay Arm	Setting Armed(Anti-Burglar), User could select the security zone to be working or notworking (After setting, do not affect the normal Arm)
Remote Control	Remote Control by the phone to Arm/Disarm or monitor
Phone Line	Phone line that could make phone call.
Armed Delay	Time from setting Arm to be Armed
Alarm Delay	Time from being triggered to Alarm and call.
Warning time of Siren	Warning time of Siren
User Password	Password for Disarm or remote control

3. Attention before using

- (1) Make sure all the Arming zones are on duty.
- (2) Avoid heavy impact and unnecessary disassembly which might incur accident or man-made damage.
- (3) When installing, avoid touching the electronics components which on the PCB with hand or metal parts.
- (4) When installing, make sure the AC power supply is stable (if the AC power supply is cut, the system will shift to backup battery automatically).
- (5) Suggested: main unit should connect with phone line. When connect with EXT phone, please set the phone number as requirement. (For Detail, please read below)
- (6) When fault, please contact with the dealer or our factory with Invoice & Warrant Card.

4. Feature & Function

- (1) LCD DISPLAY
- (2) 80 wireless zones, rolling to learn code. 4 wired zones
Wireless transmitting range is more than 200meters.
- (3) USA CPU processing circuits, more stable.

- (4) Billion Code
- (5) Available to connect with CMS
- (6) Available to set each zone to be ON/OFF
- (7) Arm/disarm by remote, 2 groups Auto Arm/Disarm, remote to Arm/Disarm, Arm/Disarm by keypad
- (8) 72 pcs alarm log, showing event detail & date (year, month, day, hour, minute).
- (9) Available to monitor Local, when alarming.
- (10) Self-check Function: easy to test & check, for adding new sensor & normal check
- (11) Emergency Function.
- (12) Built-in 85dB buzzer.
- (13) Easy to select wired/wireless PIR sensor, Door Sensor, Gas/Smoke Detector and so on.
- (14) 12V output port for wired accessories.

5. Main part & instruction

1) Main unit (front)

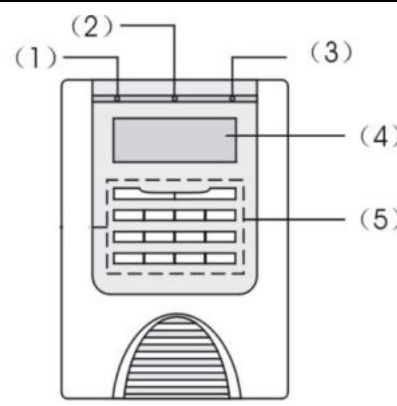
	1. Power indicator	Always on: On duty Off: Power off
	2. Arm/Disarm Indicator	Always on: in Armed status Off: in Disarmed status
	3. Low-battery indicator	Always on: Power voltage is lower than 8±0.2V Off: Power voltage is normal
	4. LCD display	Display operating menu and event log
	5. Keypad	For operating

2) Main unit left, right & back side

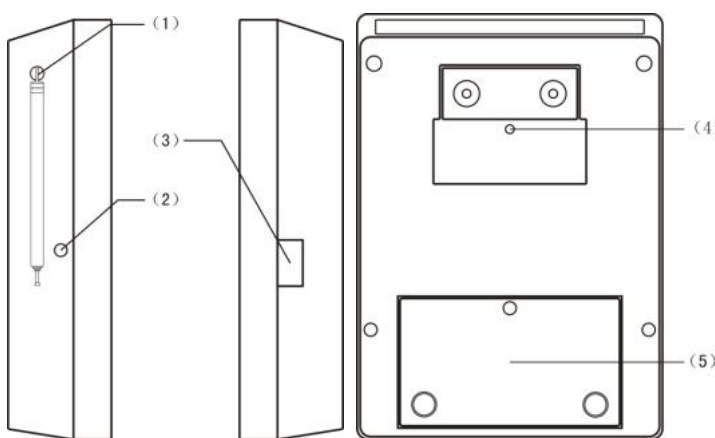
	<p>(1) Antenna: Pull out for better signal.</p> <p>(2) Mike: Monitor local, when answering Arming phone.</p> <p>(3) Power socket</p> <p>(4) Built-in Buzzer</p> <p>(5) Backup Battery Cover</p>
---	---

3) Keypad Button

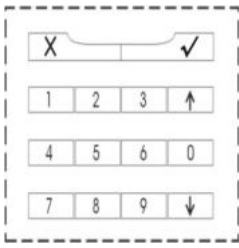
	Button	Enable		Function
		"X"key	Press "X"key	Cancel and go back.
"✓"key		Press "✓"key	Confirm and go to next.	Confirm
"↑"key		Press "↑"key	Move upward, left or backspace.	Move & Backspace
"↓"key		Press "↓"key	Move downward or right.	Move
Number Key: "0"—"9"key。				
Set to be armed by keypad	When mainframe displayed "Welcome", Press "↑" for 1.5sec., sound "Bi" once, enter vocal arm status.			

4) Main unit (top) AL-2016A

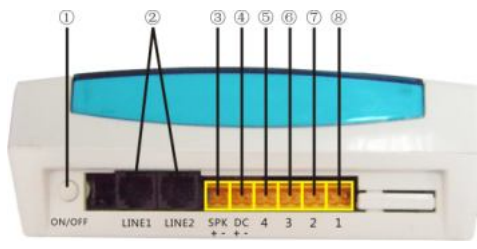

- ① Power Button: Power ON/OFF
- ② Phone port: Connect with phone line or user phone
- ③ Alarming Voltage (12V) output port : Alarming time sync with Built-in Buzzer
- ④ Power (12V) output port: Power for wired accessories.
- ⑤ Wired 4 zone, when connect with one detector, signal wire directly connect with main frame. If more than two, before connect with main frame, please connect the detectors in series.
- ⑥ Wired 3 zone, wiring same as above.
- ⑦ Wired 2 zone, wiring same as above.
- ⑧ Wired 1 zone, wiring same as above.

AL-2016A GSM

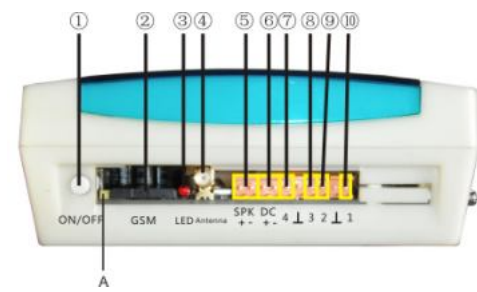

- ① Power Button: Power ON/OFF
- ② SIM card slot: Insert SIM
- ③ GSM indicator: checking GSM status
- ④ GSM Antenna: For better signal.
- ⑤ EXT-siren (12V) port: Warning time is sync with built-in buzzer.
- ⑥ Power (12V) output port: For wired accessories.
- ⑦ Wired 4 zone (no need resistance); Connecting with one detector, directly connect signal wire with this port (4), the other one connect with public port (⊥). If connect with two or more, please connect them with in series then connect the port.
- ⑧ Wired 3 zone, same as above.
- ⑨ Wired 2 zone, same as above.
- ⑩ Wired 1 zone, same as above.

A: Press "A" to open SIM card slot with something like toothpick.

5) Built-in DIP Switch:



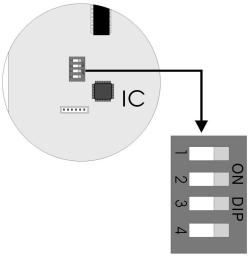



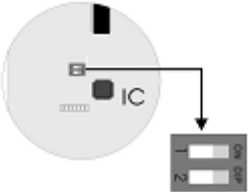



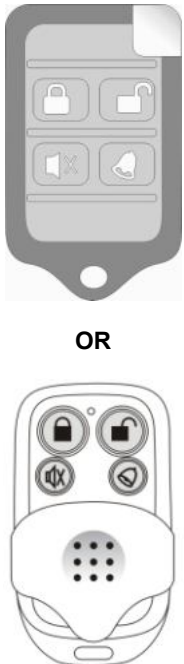

AL-2016A

	NO.	Function		Setting
	1	ON	ON	Remotely Control by phone (Default is "ON")
		1	OFF	
	2	ON	ON	Switch for restoring password (Default is "2"), when forgot password, please open the cover of mainframe, pull the switch from "2" to "ON", then power off, power on after 2sec., pull it to be "2" again. Password restored to be "000000"
		2	OFF	
	3	ON	ON	Arm/Disarm dial CMS or not (Default is "3"). If pull to "ON" and input CMS No. & User ID, it will dial CMS, when Arm/Disarm. Pull to "3", it will not dial CMS when Arm/Disarm.
		3	OFF	
4	Undefined			

AL-2016A GSM

	NO.	Function		Setting
	1	ON	ON	Switch for restoring password (Default is "1"), when forgot password, please open the cover of mainframe, pull the switch from "1" to "ON", then power off, power on after 2sec., pull it to be "1" again. Password restored to be "000000"
		1	OFF	
	2	ON	ON	Sending SMS & dial CMS or not, when Arm/Disarm (Default is "2"). If pull to "ON" and input CMS No., it will dial CMS. If no input CMS No., it will send SMS to user.
2		OFF		

6) Remote Control

	Button	Enable/Disable		Function
	ARM KEY 	Press  key	Sound "Bi", enter normal ARM status.	To be Armed
		Press  key again	Sound "Bi Bi", enter mute ARM status.	
	DISARM KEY 	Press  key	Disarm immediately & exit alarming status	To be Disarmed
	EMERGENCY KEY 	Press  key	Warn & Dial at once	To be Emergency
	PERIMETER ARM KEY 	Press  key	Sound "Bi", enter perimeter Armed	To be Perimeter Armed
Press  &  key at the same time		Enter vocal armed status without any delay.		

6. System Setting and Operation

Power on, LCD will be on, then operating as below:

I. NORMAL

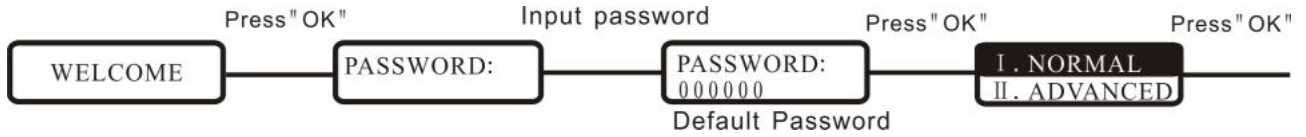

(1). PHONE

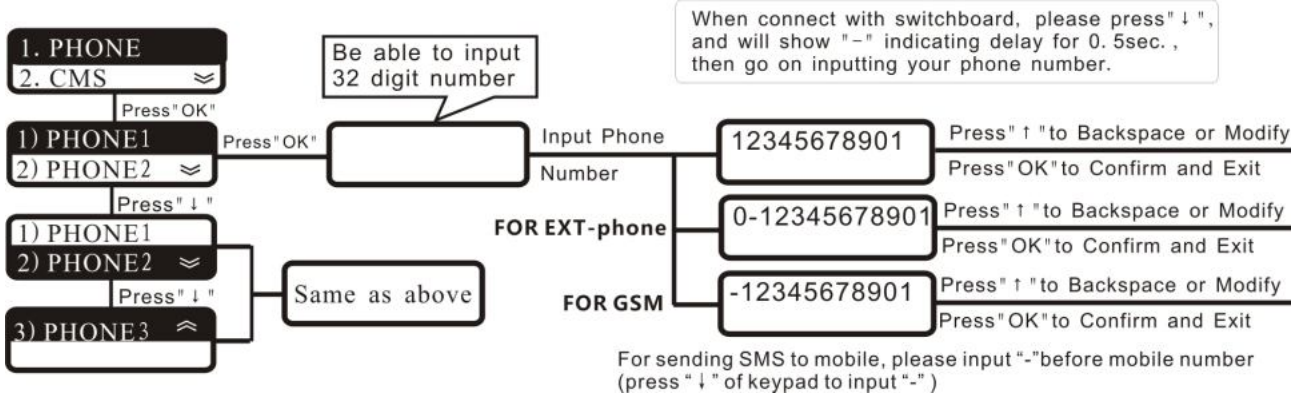

(2). CMS

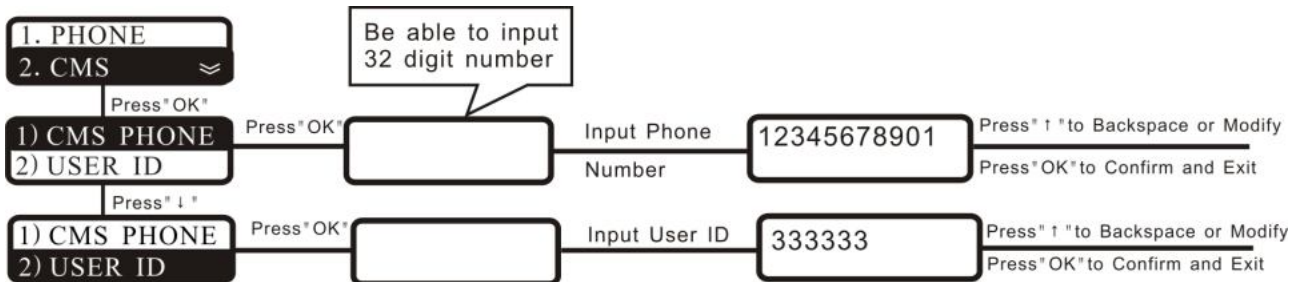

(3). PASSWORD



(4). TIME&DATE

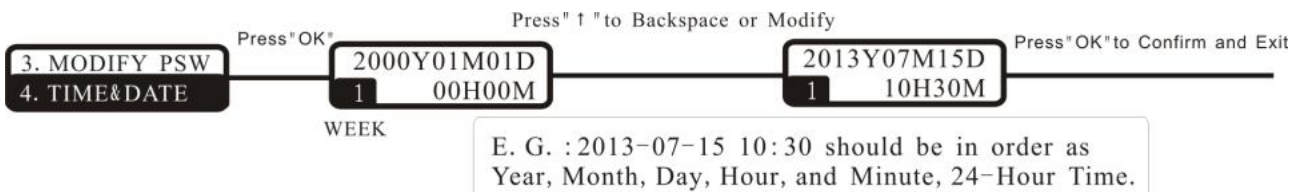

II. ADVANCED

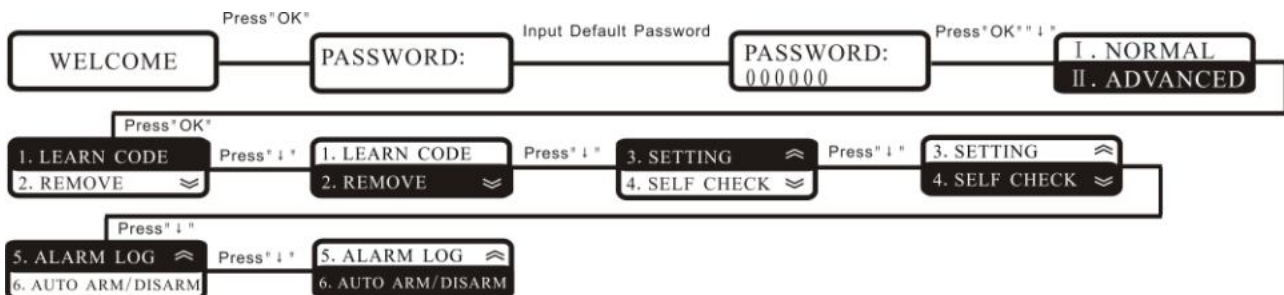

II. ADVANCED

- 1. LEARN CODE
- 2. REMOVE
- 3. SETTING
- 4. SELF CHECK
- 5. ALARM LOG
- 6. AUTO ARM/DISARM

(1). LEARN CODE

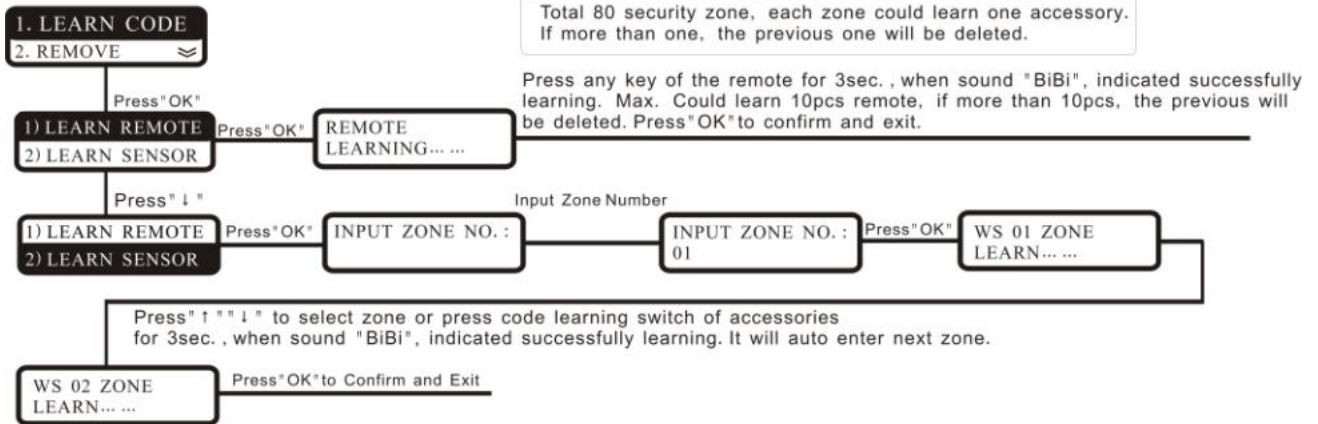

(2). REMOVE

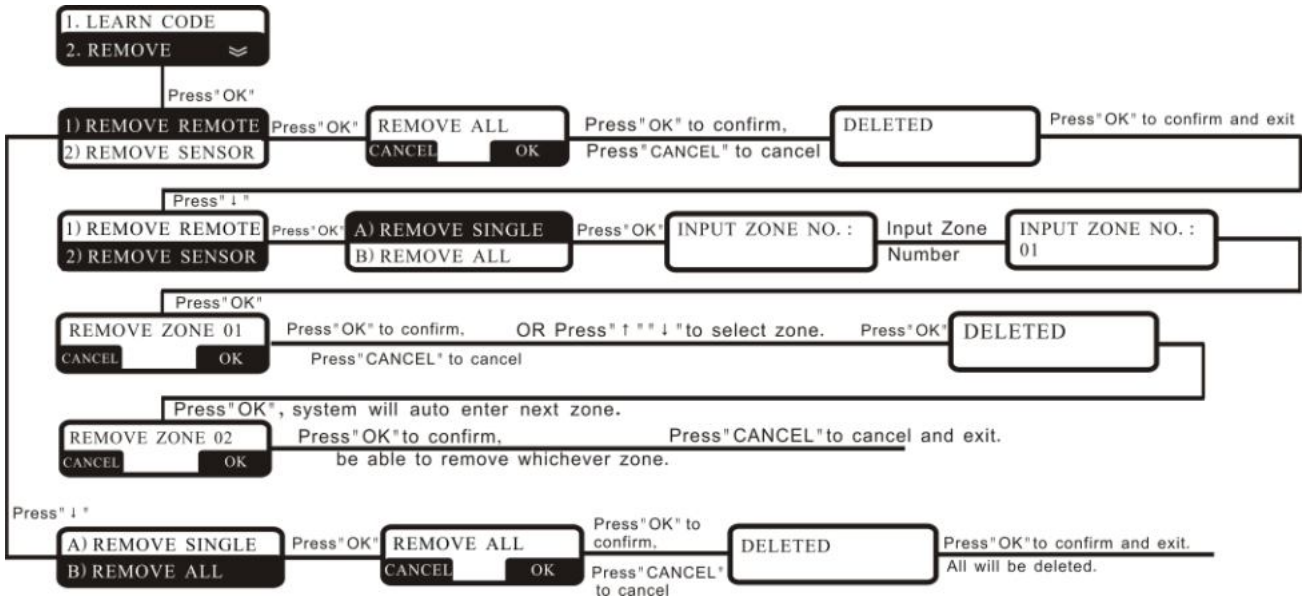

(3). SETTING

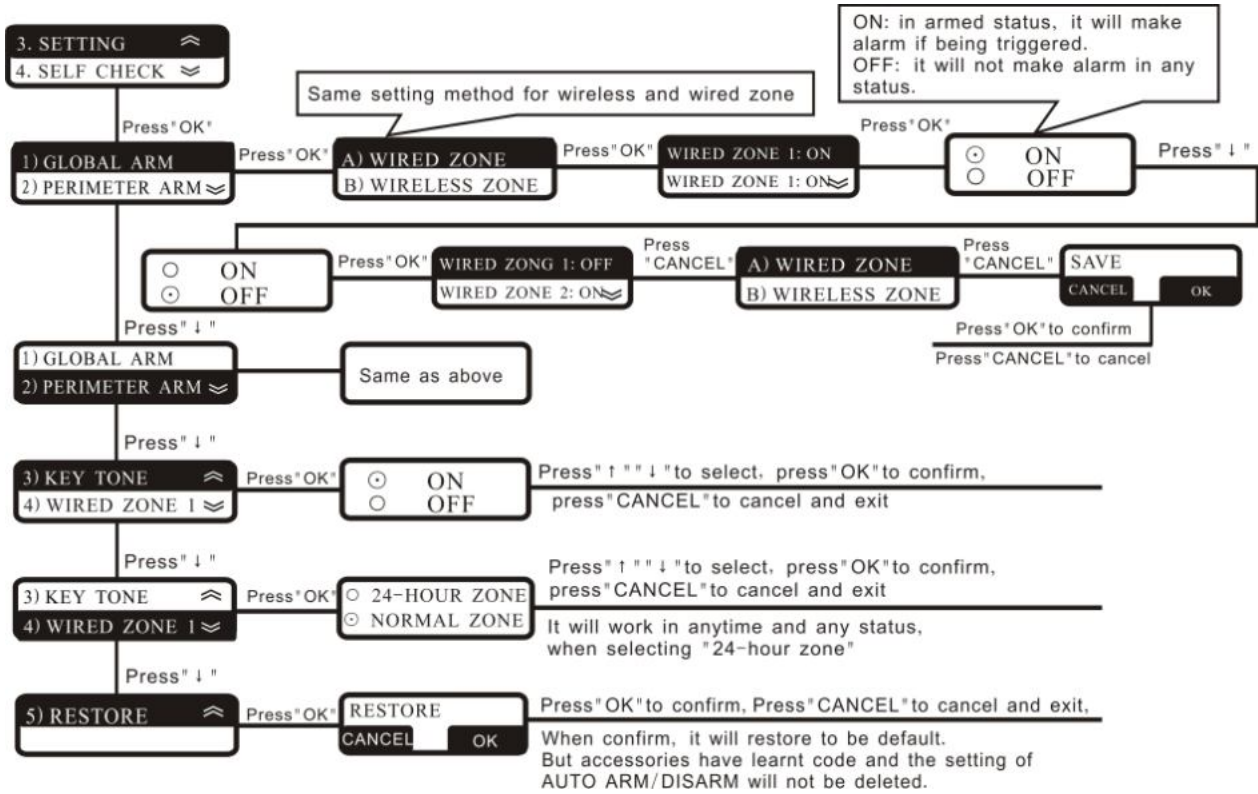

(4). SELF CHECK

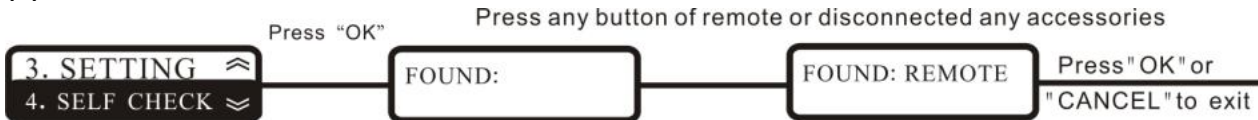

(5). ALARM LOG

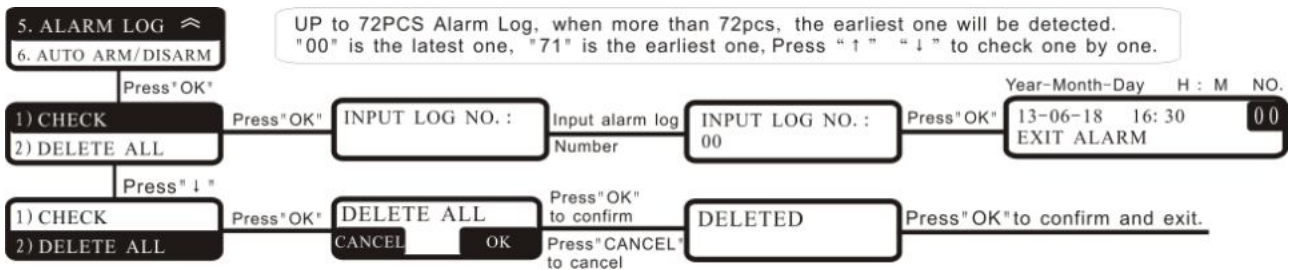

(6). AUTO ARM/DISARM

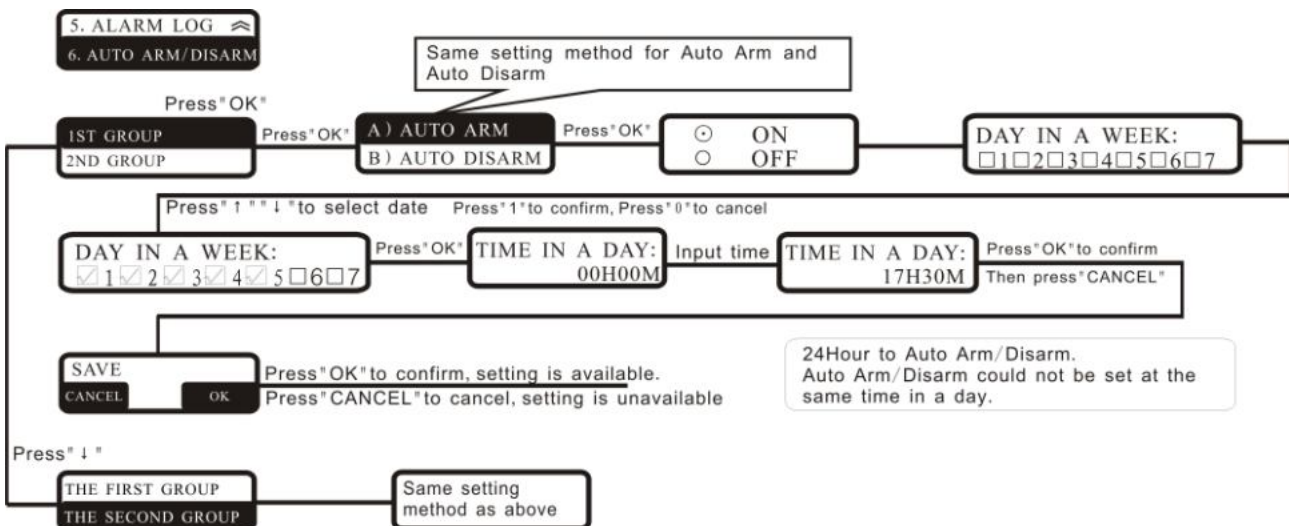

(7)Default setting

1.Delay to be Armed:	0sec.	5.Built-in Buzzer & EXT Siren:	SYNC.
2.Delay to be Disarmed:	0sec.	6.The 1 st zone:	Normal Zone
3.When Armed, default is:	Global Armed	7.Alarm Phone default is:	Null
4.default password:	000000		

7. Receive the Alarming call

In armed status, if any accessories are being triggered, the system will make alarm after delay time.

(1) Warning Alarm

If no connecting with phone line or do not input any number, when being triggered, the siren will be warning in any status.

Except the above two vocal alarming situation, If under mute alarm status, the siren will not warn.

(2) Phone Alarm

When alarming, the system will dial in order. If not being stopped, it will dial three times in cycle. (As below)

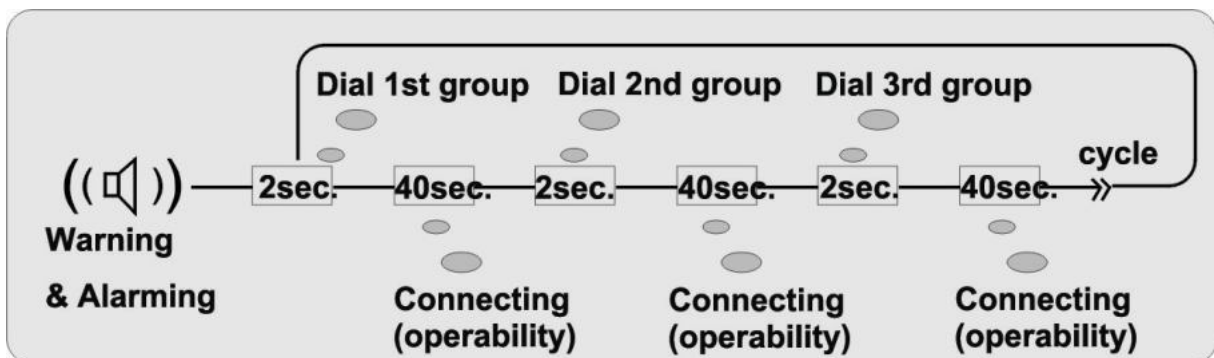

If connecting with CMS, it will dial CMS first and send alarming information. If sent successfully, it will not dial CMS again. If not, it will dial CMS three times. Then dial other three groups in cycle. (As below)

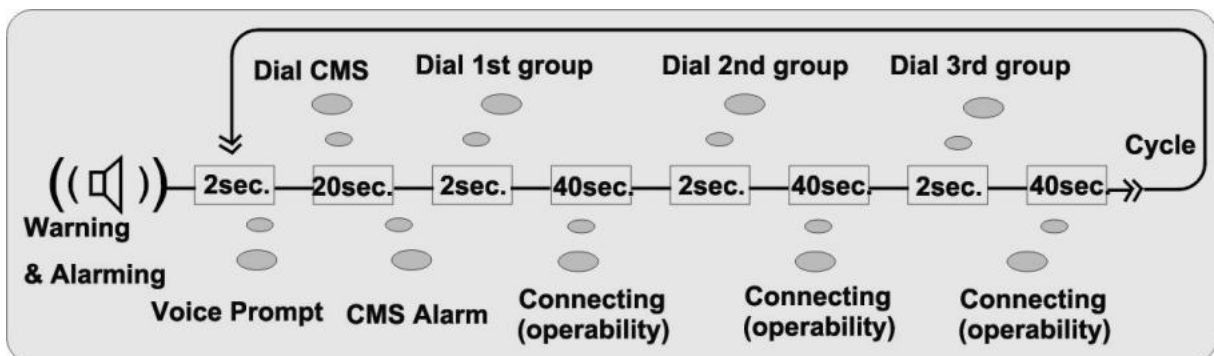

When answer the phone, firstly it is the operating voice prompt. It is available to operate according to the voice prompt. If the user does some operating, it will not dial this number in another cycle.

Phone Button	Function
Press“3#”key	When monitoring the alarming place, it is ok to press “3#” for 20sec more.
Press“5#”key	Sw itch into Vocal Alarming and hang up, then dial next number
Press“1#”key	Exit current alarming and hang up, But mainframe is still in Armed status, if being triggered, it will make alarm again.
Press“0#”key	Disarm

8. Remote Control Function

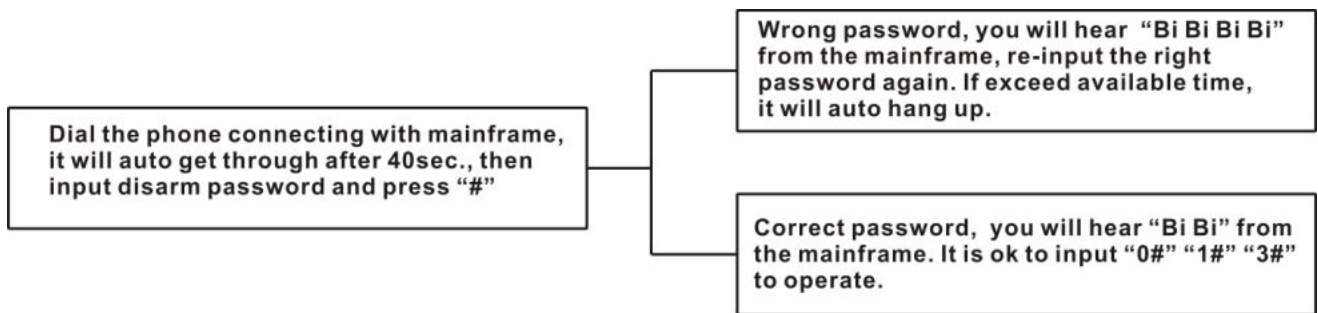

Phone Button	Function	Phone buzzer
Press“0#”key	Disarm	Sound “Bi Bi” once
Press“1#”key	ARM	Sound “Bi” once
Press“3#”key	Monitor Local	Sound “Bi” once

9. System Installing

- (1) Before using, all wireless should learn code. Security zone need to be used, should be “ON”.
- (2) For safe and better wireless signal receiving, the mainframe should install at the center. Mainframe & wireless accessories should avoid the large metal and strong magnetic region.
- (3) When using rechargeable battery, it should be charged for more than 72 hours. Please select battery from standard manufacturer for normally working.
- (4) Wiring diagram for wired accessories as below:

AL-2016A

Using screw driver to pick up the wired port, as below

Successfully picking up, as below

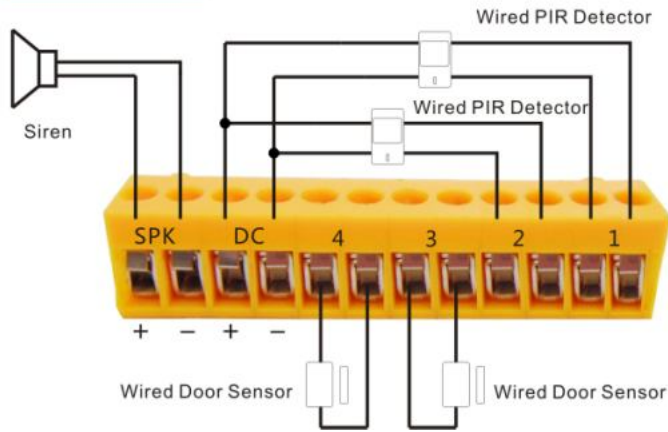
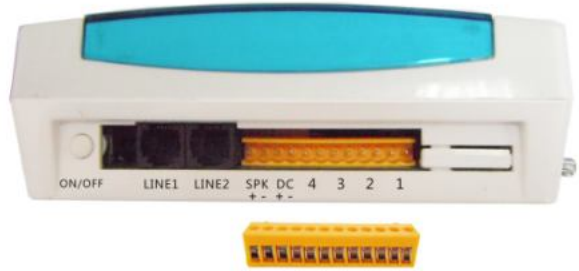
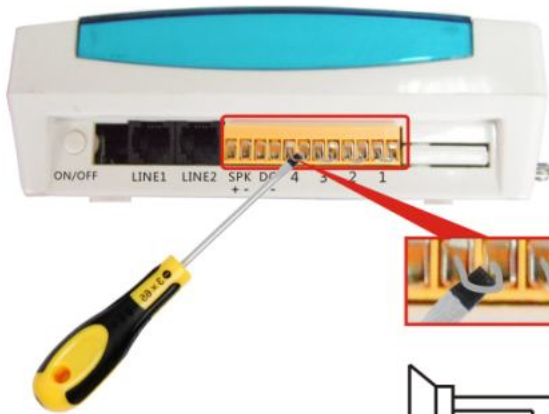

AL-2016A GSM

Using screw driver to pick up the wired port, as below

Successfully picking up, as below

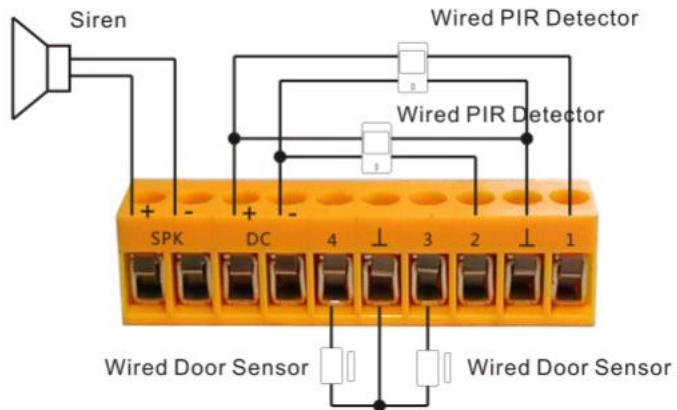
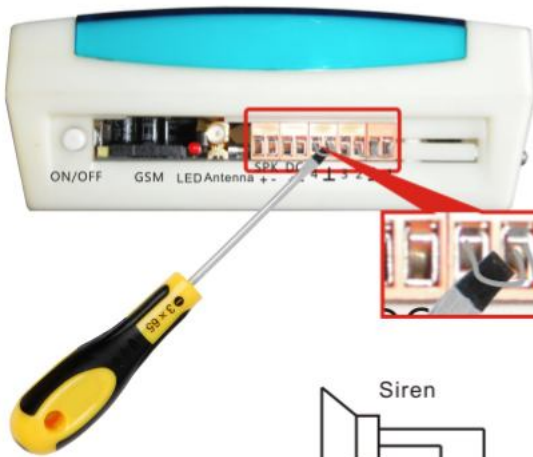

10. Technology Parameter:

- (1) Power Voltage: AC: 110V ~ 245V
- (2) Standby Current of Mainframe: $\leq 35\text{mA}$
- (3) Operating Current: $\leq 120\text{mA}$
- (4) Alarming Current: $\leq 300\text{mA}$ (not connecting with EXT siren)
- (5) Receiving Frequency: $433.92 \pm 0.5\text{MHz}$
- (6) Preset Phone Number: 3pcs phone number, 1pcs CMS NO and 1pcs User ID
- (7) Built-in Siren: $> 85\text{dB}$
- (8) Standby Time: ≥ 8 hours
- (9) Size: $20 \times 14.5 \times 6.6\text{cm}$
- (10) Wireless receiving range: $\geq 200\text{M}$
- (11) Triggered wired accessories: When disconnect, it will make alarm.
- (12) Triggered duration: 0.5sec.
- (13) Security Zone: Wireless 80, Wired 4

11. Normal Fault & Solution

Fault	The possible reasons	Solution
Power LED is OFF, LCD screen does not work.	Backup batter run out or power is cut	Charge the battery or recover power supply.
Wireless signal unavailable	same frequency interference	Contact dealer for help.
Could not dial, when Alarming	Input wrong phone number or phone line is disconnected.	Input the number, connect the phone line.
Transmitting short	Have not pulled out the antenna or close to the big metal object	Pull out the antenna or avoid closing to the big metal object.
shorten transmitting of the detector	Battery is low of the detector	Replace the battery.

11. Accessories Instruction

D-106 / D-102A Door Sensor Instruction

Overview:

D-106 / D-102A Door Sensor using imported CPU, more stable.

D-106 Instruction	D-102A Instruction
<p>Technology Parameter:</p> <p>Battery: 12V/23A Static Current: 0uA; Transmitting Current: ≤15mA; Type: ASK; Transmitting Frequency: 433.92MHz; Transmitting Range: ≥200M (clearing)</p> <p>Usage: (PIC1A)</p> <p>Learn code: Press SW1 for 3sec. LED1: Signal sending indicator LED2: Low power indicator (When undervoltage, it will be always on)</p> <p>Working Method: (PIC2A)</p> <p>Magnetic Stripe abuts against Door Sensor closely, and then takes magnetic stripe away more than 20mm, LED1 will flash once, sending warning signal.</p>	<p>Technology Parameter:</p> <p>Battery: 12V/185MAH; Static Current: 0uA; Transmitting Current: ≤12mA; Type: ASK; Transmitting Frequency: 433.92MHz; Transmitting Range: ≥220M (clearing)</p> <p>Usage (PIC1B)</p> <p>Learn code: Press K2 for 3sec. LED1: Wireless signal sending indicator LED2: Low power indicator (When under voltage, it will be always on)</p> <p>Working Method: (PIC2B)</p> <p>Magnetic Stripe abuts against Door Sensor closely, and then takes magnetic stripe away more than 20mm, LED1 will flash once, sending warning signal.</p>

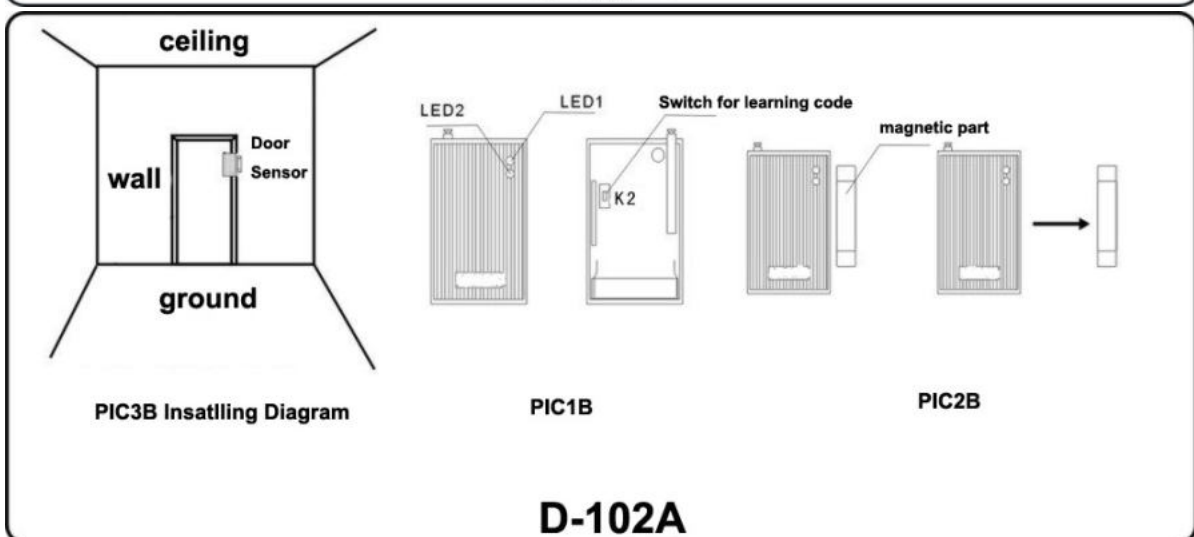
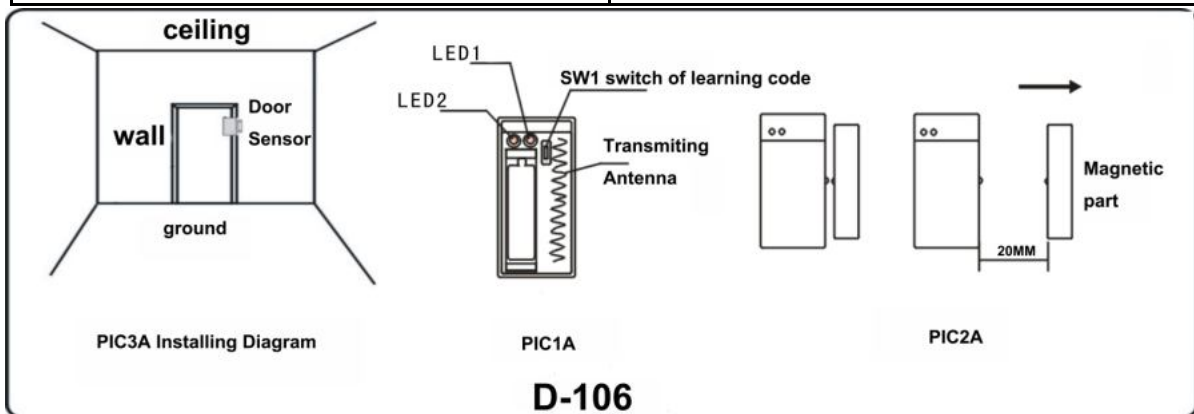

AL-413W / PIR-102A Instruction

1. Overview

AL-413W (PIC1A) / PIR-102A (PIC1B) wall mounting wireless PIR Detector make up of wireless sending circuit & infrared detecting device.

Features:

- A. Anti-false alarm & outstanding detecting function.
- B. Pure wireless design, wireless transmitting, easy installing.
- C. Power saving design, long working time.

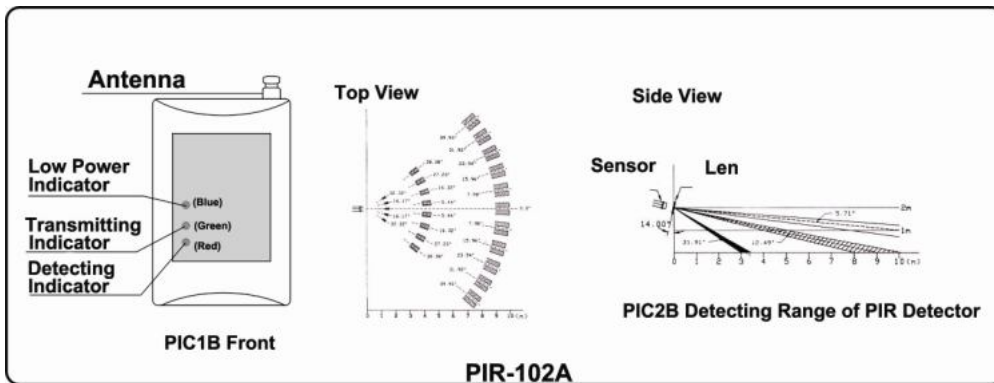
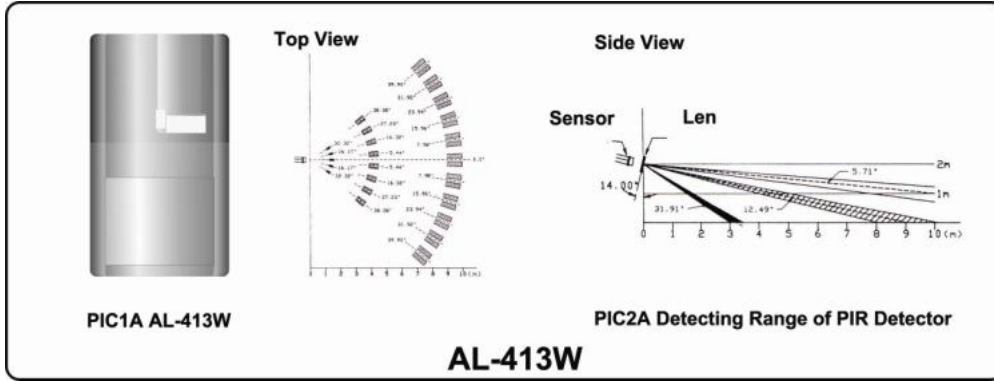

2. Parameter

AL-413W Instruction	PIR-102A Instruction
Power: 1.5V, 7 Alkaline Battery 4pcs	Power: 9V High-powered alkaline battery 1pcs
Working Current: static<25uA, being triggered<25mA (6VDC)	Working Current: static<25uA, being triggered<25mA (9VDC)
EXT Battery: static<40uA, being triggered<25mA (12VDC)	EXT Battery: static<4u A, being triggered<25mA(12VDC)
Transmitting Frequency: 433.92MHz	Transmitting Frequency: 433.92MHz
Transmitting Distance: ≥200m (open view place)	Transmitting Distance: ≥200m (open view place) PIR
PIR Detector Diagram (View PIC2A)	Detector Diagram (View PIC2B)
Sensor: Gemany Hayman Sensor	Sensor: Gemany Hayman Sensor
Detecting angle: horizontal 100° Vertical 70°	Detecting angle: horizontal 100° Vertical 70°
Detecting range: 6-12m	Detecting range: 6-12m
Size: 10.7*5.8*4.7cm	Size: 6.7*4.5*5.1cm
Working Temp: -10°C to +40°C	Working Temp: -10°C to +40°C
Storage Temp: -25°C to +55°C	Storage Temp: -25°C to +55°C
Anti-radiation > 1V/M	Anti-radiation > 1V/M
Anti-visible light > 6500LUX	Anti-visible light > 6500LUX

3. Installation & Usage of Detector

3.1 Installing guide to avoid false alarm

- A. Avoid sunshine or strong light
- B. Using high-powered alkaline battery
- C. Avoid the floating subject, e.g. clothes or curtain, strong wind may cause false alarming.
- D. Avoid facing heating unit, such as air conditioner, refrigerator, fan and so on.

3.2 Installing

Use screw to fix the bracket on the wall, about 2.1m to 2.8m from the ground. (PIC3A or PIC3B)

3.3 Working Mode

Detecting Indicator: Detected someone within detecting range, red LED will be flashing.

Signal transmitting indicator: When transmitting, Green LED will be on for.

Low Voltage: When the voltage of battery is low, the Blue LED will be always on (indicating: time to replace battery).

Check when power on: Every time power on, detector will enter 1 min self-check mode, and the Red LED will be flashing. If without being triggered, it will enter testing mode.

Code learning mode: Under testing or working mode, press code learning switch, the Green LED will be on for 3sec., then enter code learning mode, enter testing mode after 3sec. (PIC5A or PIC4B)

Selecting working time for detector: Pull to 180S, detector will send signal every 180sec. That is saving power. Pull to 10s, detector will send signal every 10sec. That is for installing test.

3.4 Walk to test

Walk into detect range, it should flash once, start transmitting wireless alarm signal.

3.5 Code learning

Firstly, enter code learning status, long press code learning switch (PIC5A or PIC4B), Green indicator will be always on. When mainframe received that signal, it will sound to indicating code learning finish. If not, please repeat the above operating.

3.6 EXT Power for AL-413W

It is able to connect with 12V DC Power. Please check PIC4A for power socket (Default is unavailable, unless required by user)

4. NOTE

- A. Avoid to drop or impacts, or will cause damage.
- B. Avoid touching sensor to keep mirror surface clean.
- C. After testing, please set to normally work mode.
- D. Do regularly checking for better status.

