

1

E LIGHT N.E LIGHT

T1-MAIN

PLC

ENCODER

MOTOR

Title	Document Number	Rev
Size	B	1
Date:	Sunday, May 10, 2020	Sheet 1 of 7

FUJI-MITSU

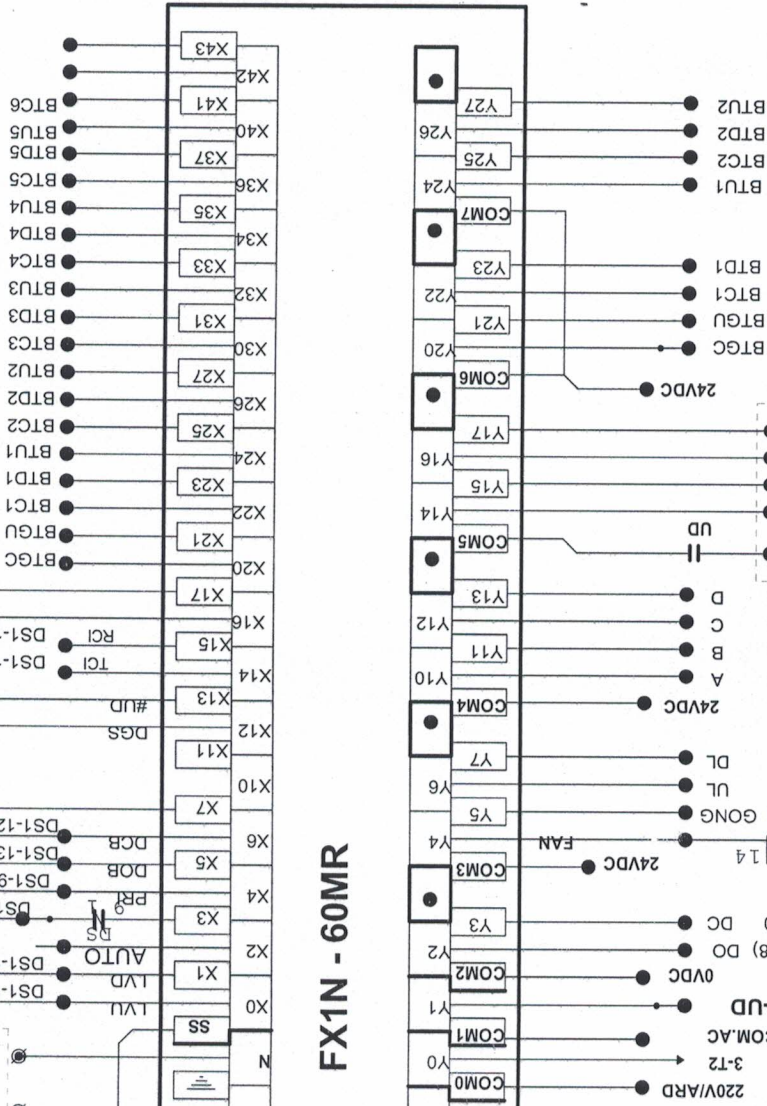
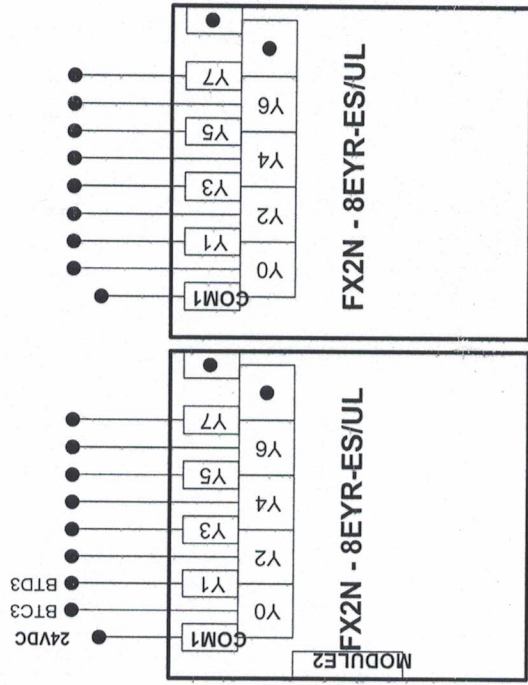
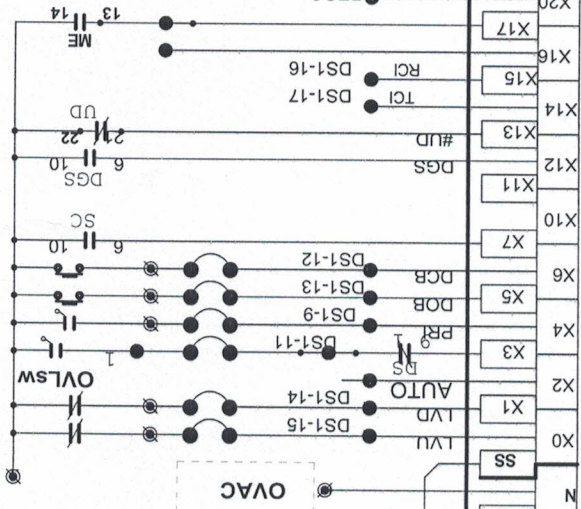
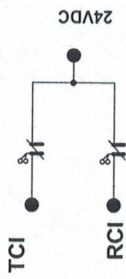

Title	
Size	B
Document Number	
Rev	1
Date	Monday, May 11, 2020
Sheet	2 of 7

13 FAN DC

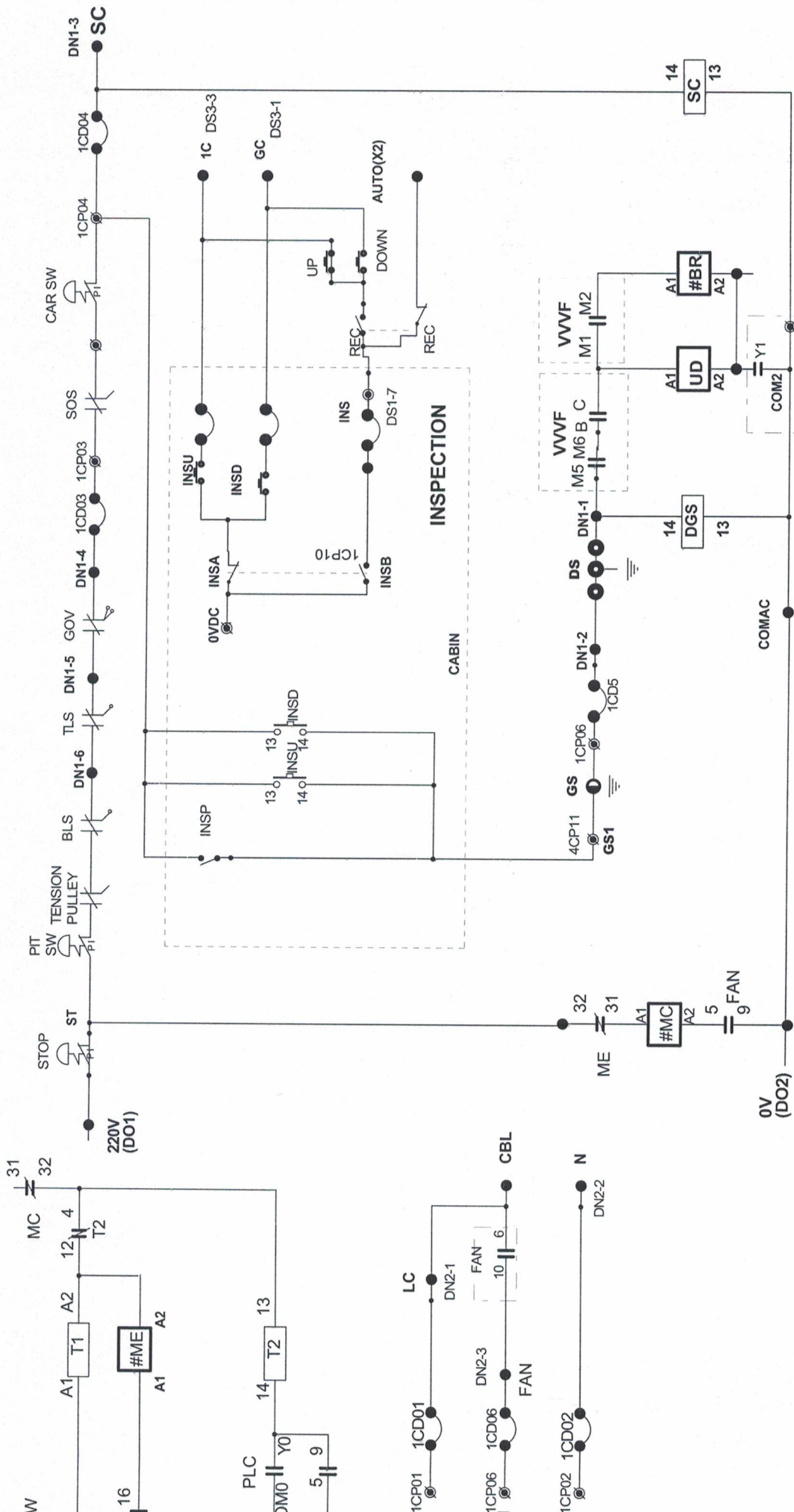

VF H2-3 = 6 ;
H2-1=50

LC - N : O CAM DIEN, DEN QUA CON TAC
 FAN - N : DEN, QUAT THEO THOI GIAN
 ELIGHT - N. ELIGHT : DEN CUU HO

Title	
Size	B
Document Number	
Date:	Sunday, May 10, 2020
Sheet	3 of 7
Rev	1

WIRE 04 (INTERCOM)

WIRING BUTTON CAR

WIRE 24

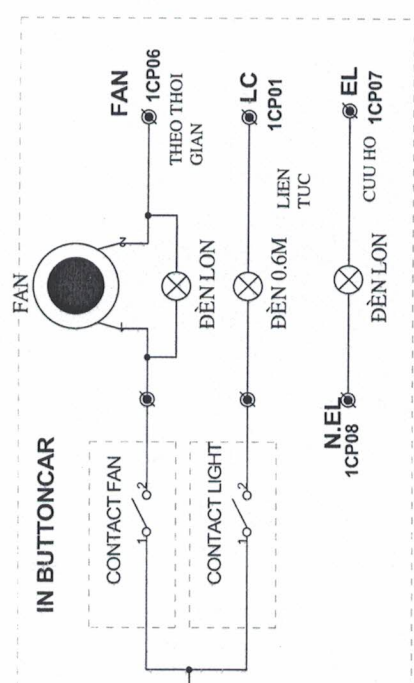
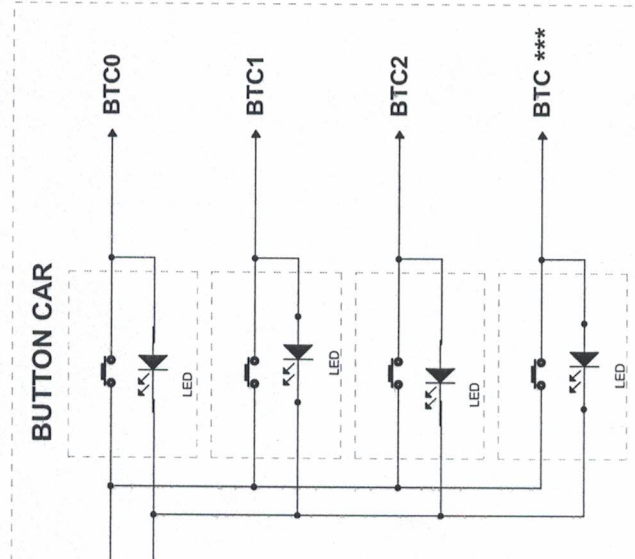
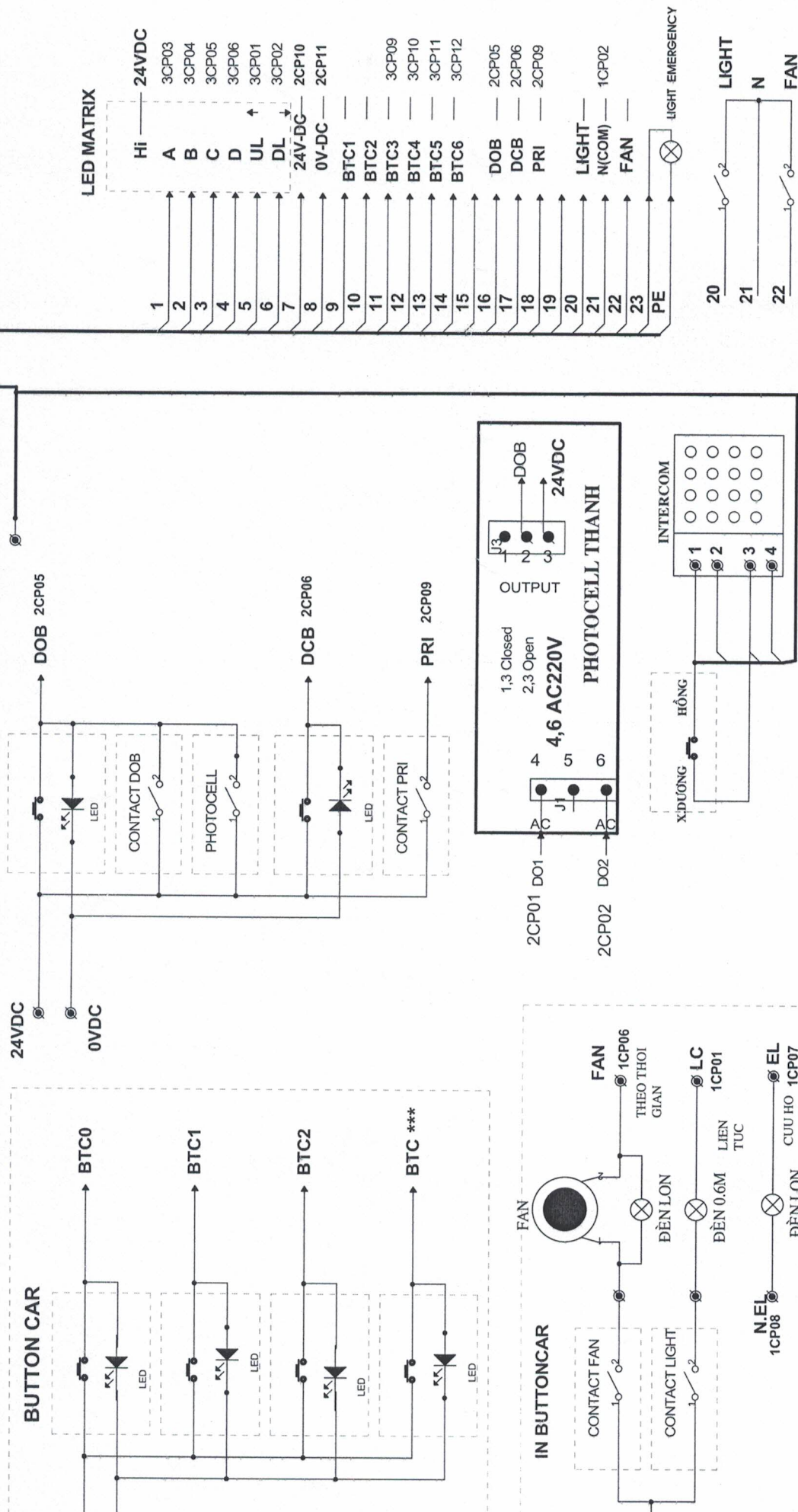

Title	
Size	B
Document Number	
Date:	Monday, May 11, 2020
Sheet	4 of 7
Rev	1

FLOOR BUTTON

E 5



WIRE 5

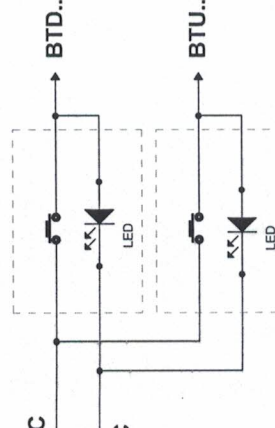

WIRE 5 x2

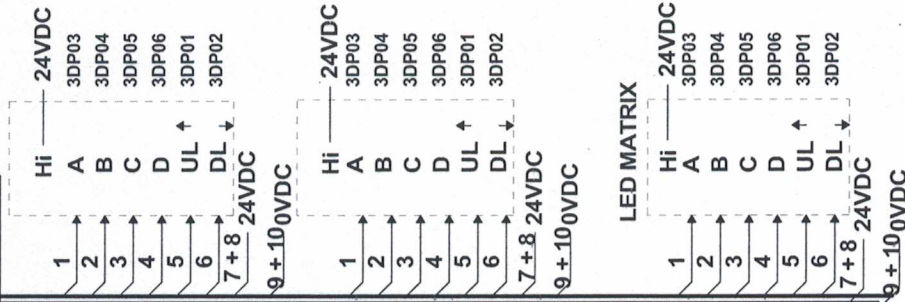

SAFETY PIT WIRE 06

BOTTOM LIMIT

TOP LIMIT

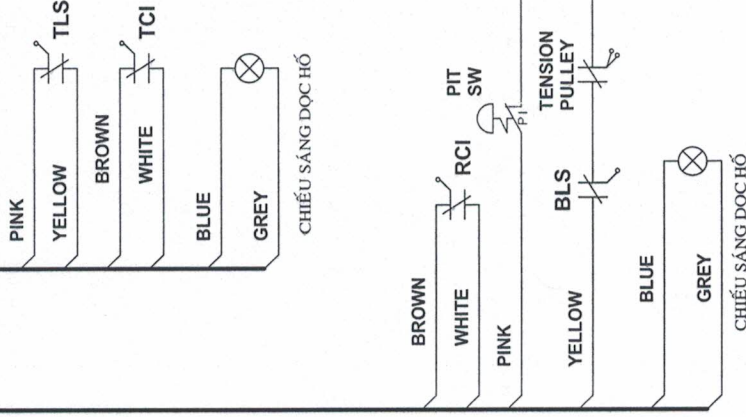

WIRE DOORLOCK

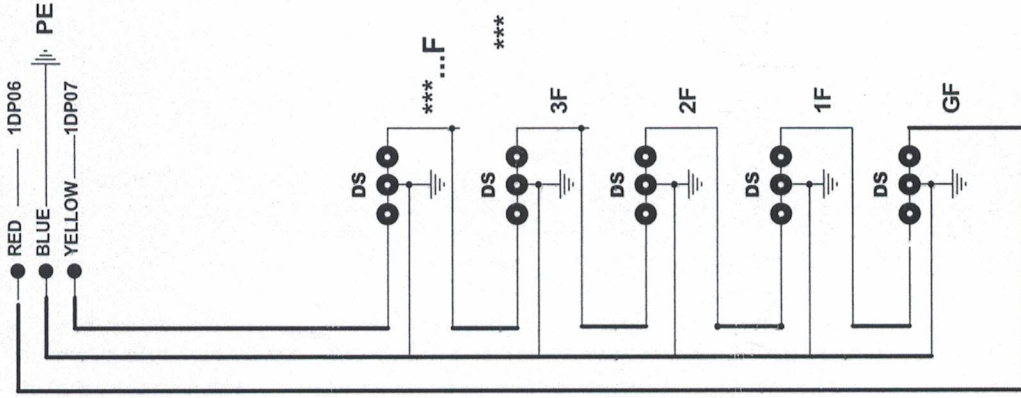

SAFETY DOOR

Title	
Size	B
Document Number	
Rev	1
Date	Monday, May 11, 2020
Sheet	5 of 7

17	TCI
16	RCI
15	LUV
14	LVD
13	DOB
12	DCB
11	OVLsw
10	OLlight
9	PRI
8	GONG
7	INS
6	UL
5	DL
4	A
3	B
2	C
1	D
DS3	

ST	BLS	TLs	GOV	SC	GS	DS
1	2	3	4	5	6	7

3	5D
2	5C
1	4U
0	4D
9	4C
8	3U
7	3D
6	3C
5	2U
4	2D
3	2C
2	1U
1	1C
DS1	

4	24V
3	24V
2	0V
1	0V
DS2	

DN1

LC	N	FAN	EL	EN	D1	D2	D3	D4	D5	BR+	BR-
1	2	3	4	5	6	7	8	9	10	11	12

DN2

IUPS	IUPS	OUPS	OUPS
1	2	3	4

DN3

L1	L2	L3	N	U	V	W	PE
1	2	3	4	1	2	3	4

DP1

DOMINO ON CABIN

CD1

CD2

P	DOMINO 1	1CD1
2.1	1CP01	LC
1.4	1CP02	N
04	1CP03	GOV
05	1CP04	SC
06	1CP05	GS
P12	1CP06	FAN
07	1CP07	EL
08	1CP08	N.EL
P11	1CP09	GONG
07	1CP10	INS
P01	1CP11	LUV
02	1CP12	LVD

CP	DOMINO 2	1CD13
5DP03	2CP01	DO1
5DP04	2CP02	DO2
5DP05	2CP03	DO3
5DP06	2CP04	DO5
2DP05	2CP05	DOB
2DP06	2CP06	DCB
2DP07	2CP07	OVL SW
2DP08	2CP08	OVL light
2DP09	2CP09	PRI
5DP10	2CP10	+24V
5DP12	2CP11	OVDc
	2CP12	PE

CP	DOMINO 3	2CD1
3DP01	3CP01	UL
3DP02	3CP02	DL
3DP03	3CP03	A
3DP04	3CP04	B
3DP05	3CP05	C
3DP06	3CP06	D
3DP08	3CP07	BTC1
3DP10	3CP08	BTC2
4DP01	3CP09	BTC3
4DP04	3CP10	BTC4
4DP07	3CP11	BTC5
4DP10	3CP12	BTC6

CP	DOMINO 4	2CD13
2CP01	4CP01	BTC7
2CP02	4CP02	
2CP03	4CP03	
2CP04	4CP04	INT.C1
2CP05	4CP05	INT.C2
2CP06	4CP06	INT.C3
2CP07	4CP07	INT.C4
2CP08	4CP08	
2CP09	4CP09	
2CP10	4CP10	
2CP11	4CP11	GS1
2CP12	4CP12	PE

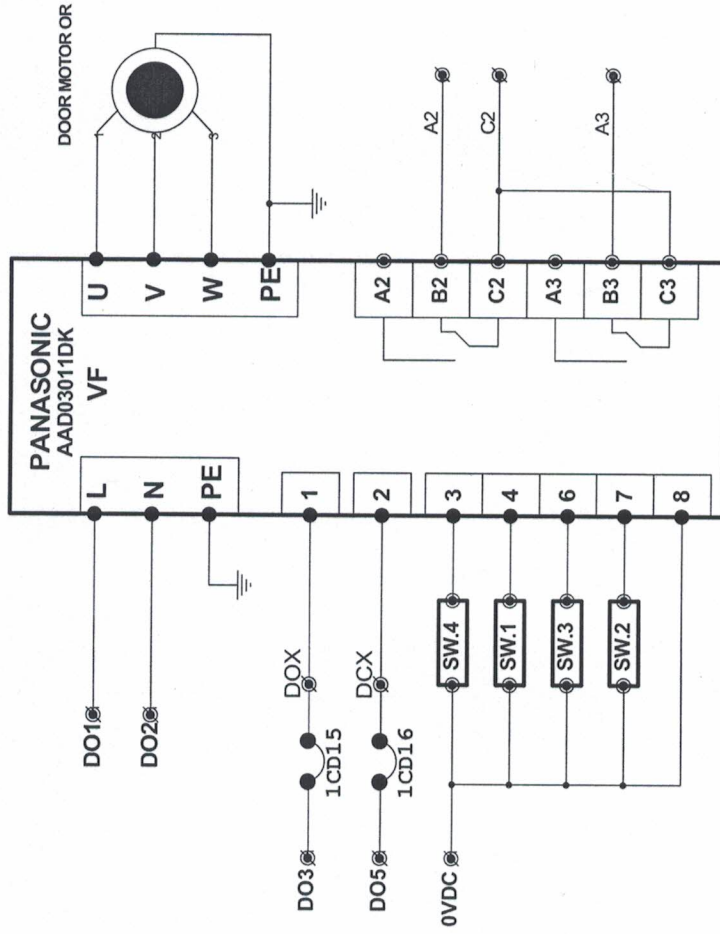

Title	
Size	B
Document Number	DOOR
Date:	Monday, May 11, 2020
Sheet	7 of 7
Rev	1

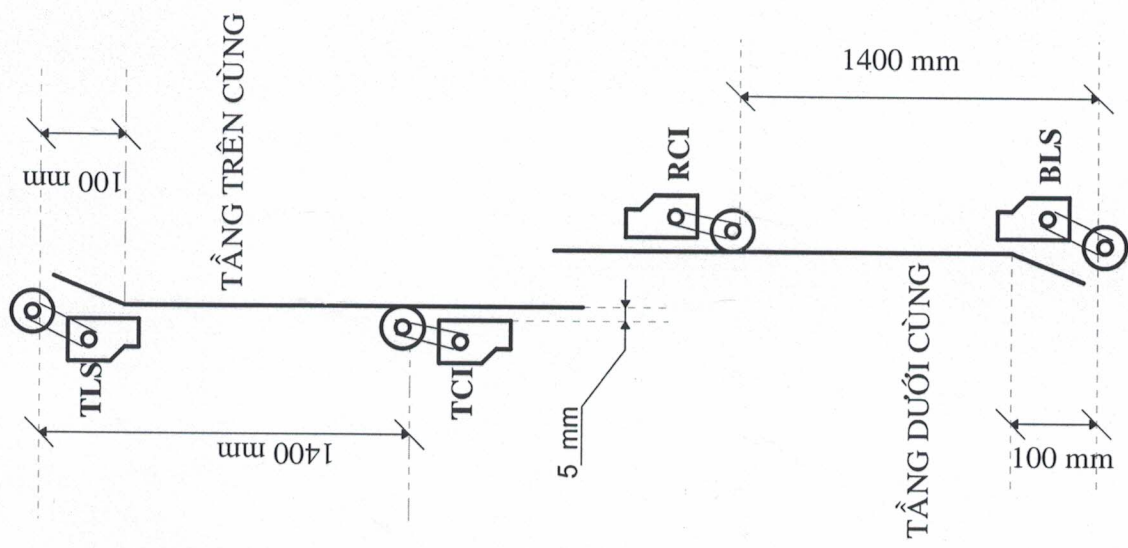
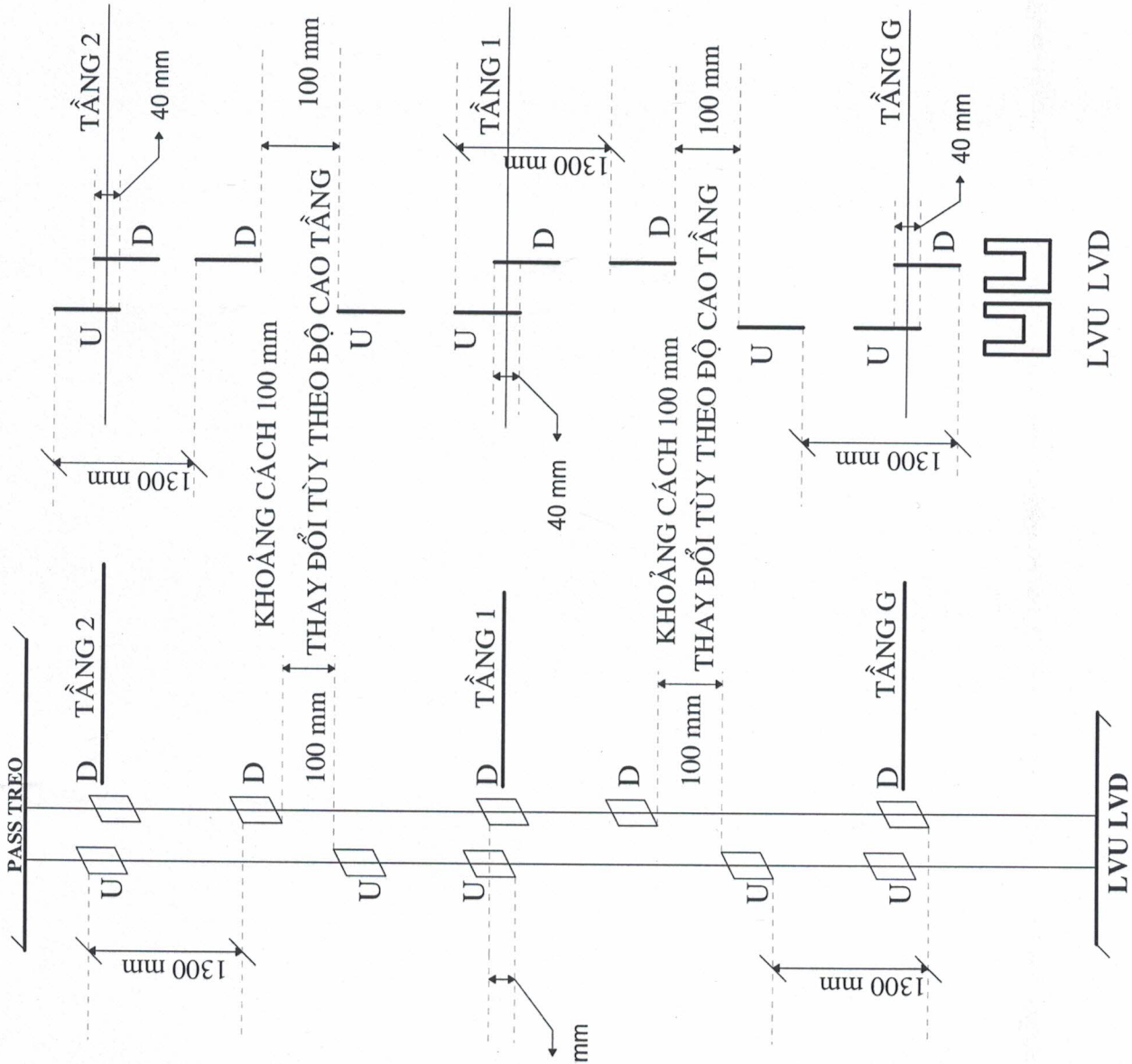

Title	LẮP LÁ CỜ + HỘP GIỚI		
Size	B	Document Number	HAN
Date	Sunday, May 10, 2020	Sheet	9 of 9